

ISSN (Print): 2077-7973

ISSN (Online): 2077-8767

DOI: 10.6977/IJoSI.201903_5(3)

International Journal of Systematic Innovation



VOL.05, NO.03

March, 2019

Published by the Society of Systematic Innovation

Opportunity Identification
&
Problem Solving

The International Journal of Systematic Innovation

Publisher:

The Society of Systematic Innovation

Editorial Team:Editor-in-Chief:

Sheu, Dongliang Daniel (National Tsing Hua University, Taiwan)

Executive Editor:

Liu, Tien-Lun (Chung Yuan Christian University, Taiwan)

Associate Editors (in alphabetical order):

- Cavallucci, Denis (INSA Strasbourg University, France)
- Chen, Grant (South West Jiao Tong University, China)
- Roland De Guio (INSA Strasbourg University, France)
- Feygenson, Oleg (Algorithm Technology Research Center, Russian Federation)
- Filmore, Paul (University of Plymouth, UK)
- Kusiak, Andrew (University of Iowa, USA)
- Lee, Jay (University of Cincinnati, USA)
- Litvin, Simon (GEN TRIZ, USA)
- Lu, Stephen (University of Southern California, USA)
- Mann, Darrell (Ideal Final Result, Inc., UK)
- Sawaguch, Manabu (Waseda Univer-

sity, Japan)

- Shouchkov, Valeri (ICG Training & Consulting, Netherlands)
- Song, Yong-Won (Korea Polytechnic University, Korea)
- Tan, R.H. (Hebei University of Technology, China)
- Yoo, Seung-Hyun (Ajou University, Korea)
- Yu, Oliver (San Jose State University, USA)

Assistant:

- Chu, Yasmine

Editorial Office:

The International Journal of Systematic Innovation

5 F, # 350, Sec. 2, Guanfu Rd, Hsinchu, Taiwan, R.O.C.

e-mail: editor@systematic-innovation.org

web site: <http://www.IJoSI.org>

CONTENTS

MARCH 2019 VOLUME 5 ISSUE 3

- Design for the Adjustable High Heel
..... Jyhjeng Deng and Teng-Hsuan Lin **1-16**
- The Patent Map of a Measuring Cup
..... Jyhjeng Deng and Juin Yi Lee **17-27**
- The Origin of the Reverse Umbrella
.....Jyhjeng Deng **28-46**
- Innovative Solutions for Traditional Saudi Arabian Costumes Using TRIZ Principles
..... Wafa H. Shafee and Laila A. Feda **47-61**
- A Study on Design Thinking Based Creative Product Design Process in a Design
Project
..... Chun-Ming Yang, Thu-Hua Liu, and Ya-Yi Zheng **62-71**
- Review of Systematic Software Innovation Using TRIZ
..... Usharani Hareesh Govindarajan, D. Daniel Sheu and Darrell Mann **72-90**

Design for the Adjustable High Heel

Jyhjeng Deng^{1*} and Teng-Hsuan Lin²

¹ Industrial Engineering and Management Department, DaYeh University, Taiwan

² Department of Environmental Engineering, DaYeh University, Taiwan

*Corresponding author, E-mail: jdeng@mail.dyu.edu.tw

(Received 18 August 2017; final version received 21 December 2018)

Abstract

High-heel shoes with a dual function of working as both high heels and flats have long been sought for ladies. The dual-function high heels not only allow the wearer to go out with only one pair of shoes but also save time in commuting back and forth between home, office, and venues for social gatherings. Mime et Moi, a German high-heel brand, makes a dual-function high heel where the heel can be switched between different heights. The drawback of this approach is that the user needs to carry the extra heel in her purse, causing inconvenience. Other approaches are described in various patents. Among them, Camileon Heels uses a pivotal heel mechanism such that the shoes are high heeled during normal office time but can be converted to flats during leisure time by bending the heel around the pivot. The pivotal mechanism and locking/unlocking mechanism are intriguing and complex. Investigation of an adjustable high heel shows that the root problem is the technical contradiction of the shank. The contradiction is solved by changing the shape of the shank. We change the shape from the S shape to a curved surface located from the middle sole to the rear sole. This paper also uses the TRIZ inventive principle to analyze the patents WO2016/179675 and CN205106566 and applies inventive principle 1, segmentation, to get a simpler version of a high heel with a dual function. A prototype is prepared to demonstrate its usage.

Keywords: Locking mechanism, Pivotal heel mechanism, Segmentation, TRIZ inventive principle, Shank.

1. Introduction

Social gatherings are an important activity in human society. People are social creatures. Through social activities, people get support, security, happiness, and recognition. As woman rights expand throughout the world, social gatherings for women have started to become popular. Most of the women work. As for single or even married women, wearing high heels to attend formal gatherings is required by dress codes. After the gathering, it is nice to wear a flat in order to feel less stressed. Thus there is a need for dual-function high heels.

There have been many attempts in various countries to solve the problem of a high heel with a dual function. However, many of them are in the stage of concept drawing; for example, the famous Skywalker, as shown in Fig. 1. It was originally designed by a group of students in Greece in 2014 (Tsagari, 2014). They have been trying to find a manufacturer to make it a commercial product, but to no avail. However, there is a successful German company, Mime et Moi (Kausch, 2018), that has brought dual-function high heels onto the market, as shown in Fig. 2. It is claimed that the flats can be easily converted to high heels, and

vice versa, in four steps, as shown in Fig. 3. In Step 1, the lever is pulled firmly backwards until the heel releases and then the heel is pulled backwards. In Step 2, the lever is pulled into the closed position and the new heel is inserted until it snaps into place. In Step 3, the weight is placed on the toe bed (A) and then the wearer presses firmly with the heel of the foot (B) until the high heel locks into place. In Step 4, then press on the toe bed (A) and again press on the heel (B). Now the high heel is fixed. Based on the conversion process, however, the user needs to carry an extra heel in her purse, which causes inconvenience. This prompts the question: would it not be wonderful if the high-heel shoes could be automatically converted into flats without carrying the extra part?



Image credit: SkyWalker

Fig. 1 Skywalker

(a) High heel

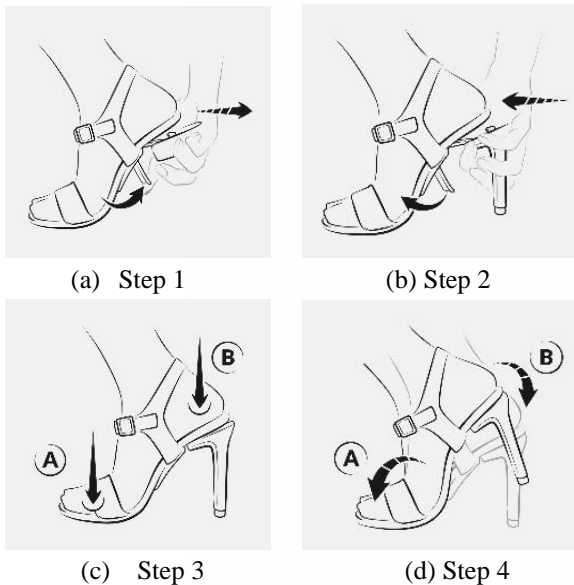

(b) Flat

Fig. 2 High heel and flat

Fig. 3 Four steps of converting flat to high heel

The rest of the paper is organized as follows: Section 2 provides a literature review of the works on dual-function high heels and TRIZ inventive principles. Section 3 gives a detailed description of the innovative technology used in dual-function high heels. Section 4 concludes the paper.

2. Literature review

High heels are a type of shoe in which the heel, compared to the toe, is significantly higher off the ground. The origins of the heel trace back to Persian warriors of the 10th century who rode horses and needed to hold tight to the saddle (High-heeled shoe, Wikipedia, 2018). Heels were later regarded as the sign of a wealthy status, because high-heel shoes are so impractical that one cannot work while wearing them. The first recorded instance of a high-heeled shoe being worn by a woman was by Catherine de' Medici in the 16th century. Up until that time, women had been wearing platform shoes in Europe. During the 17th century, courtesans began wearing high heels. As time went by, heels became more associated with women, and men wore heels less often. During the Enlightenment, European men quit wearing high heels in favor of more sensible footwear. It was not until the 19th century that women began wearing heels again (The history of high heels, 2018). A more stable stiletto was created for women during the 1950s. However, it was difficult to walk in them. High heels force women to walk in a way that adds stress to the hips and back by causing their rear to move, their hips to have to compensate and wiggle, and their chest to expand out. They thus create biologically determined markers of mating attraction. It is well known that those in high heels were judged as significantly more attractive by both men and women than those who wore flats.

2.1 Design process of high heel

The design process of high heels is just like the process of any commercial product. It starts with research, then development, refinement, and, finally, determination. In the research stage, a market survey is conducted and fashion data are collected. In the development stage, a theme is decided and its market is segmented. A sketch of the high heel is then drawn. In the refinement stage, the upper, sole, and heel are developed, and the material and accessories are provided. Drawings are then modified and finalized. In the determination stage, each part of the high-heel shoe must be confirmed with its materials. A prototype is made (Lee, 2012). In the determination stage, a shoe last is

needed to make a prototype (Luximon, 2013). A shoe last is a mechanical form that has a shape similar to that of a human foot. It is used by shoemakers in the manufacture and repair of shoes.

2.2 Shoe human factors and market

Generally speaking, when designing comfortable footwear, several human factors are considered. They are: a moderate or low heel (<2 in.), a cushioned midsole, breathable, conformable uppers, an adjustable fastening (e.g., laces, straps) and a stable heel counter. General shoe fitting principles include an understanding of posture, overall length, heel-to-ball length and flex angle, ball joint-to-toe length, heel and seat fit, instep, waist and arch fit, joint width and vamp, top line, throat and entry, patterns and styles, and measurement and size systems. Various factors can affect foot posture, including age and disease processes. When customized footwear is needed, a 3D scanner can be used to reconstruct the profile of the foot. Then a pair of shoes can be made with all the human aspects being considered. According to Kouchi's (2012) research on high-heeled shoes, the effects these have on wearers are: 1. discomfort, corns, bunions, pain, deformation; 2. increased risk of sprains and falls; 3. fatigue and pain; 4. low back pain and arthritis. The last three effects are due to change in the forces operating on the body and change in gait; the first one is caused by the foot sliding down the footbed. A footbed simulator is used to manipulate various footbed parameters to achieve greater comfort (Goonetilleke and Weerasinghe, 2012).

The market for high-heeled shoes grew from 2013 to 2017 and will reach its peak in 2023. In 2017, the global revenue from high heels was nearly 34.1 billion USD. The three leading brands of high-heeled shoes are Pierre Hardy, Manolo Blahnik and Jimmy Choo. The major regions that play a vital role in the high-heeled shoes market are North America, Europe, China and Japan. The three most important types of high-heeled shoe products are the stiletto heel, court shoe and wedge boots (Maia Research, 2018).

In sum, high-heeled shoes are a rich market. If comfort, convenience and safety are achieved through an adjustable high-heeled design, this could be the next star of the high-heeled shoes market.

2.3 Drawbacks of wearing high heel

Wearing high-heel shoes causes more physiological problems than flat shoes. It has been reported (Baaklini et al., 2017) that an estimated 78% of women

regularly walk in high heels. However, up to 58% complain about low back pain, which is commonly thought to be caused by increased lumbar lordosis. Besides, regarding the influence of high-heeled shoes on venous function, Filho et al. (2012) evaluated 30 asymptomatic women (mean age, 26.4 years) wearing appropriately sized shoes by air plethysmography (APG), a test that measures changes in air volume on a cuff placed on the calf, while they performed orthostatic flexion and foot extension movements and altered standing up and lying down. The test was repeated in four situations: barefoot (0 cm), medium heels (3.5 cm), stiletto high heels (7 cm), and platform high heels (7 cm). The experiment concluded that high heels reduce muscle pump function, as demonstrated by reduced ejection fraction (EF) and increased residual volume fraction (RVF) values. The continuous use of high heels tends to provoke venous hypertension in the lower limbs and may represent a causal factor of venous disease symptoms. Another clinical survey of about 200 women (Borchgrevink et al., 2016) showed that for women aged 40–66 years wearing high-heeled shoes had not caused foot deformation, but it did cause more foot pain and callosities. There are many more studies (Moore et al., 2015; Wiedemeijer & Otten, 2018) indicating that wearing high-heel shoes indeed causes more physiological problems (e.g. altered gait) and injuries than wearing flat shoes.

2.4 Flexheel technology

Despite its drawbacks, however, the loveliness of wearing high heels has urged many ladies to risk their health because it is suggested (Morris et al., 2013) that there is a strong contemporary association between high heels and female sexuality. How can one remain sexy and relaxed at the same time? This contradiction is solved by the principle of time separation. The solution has been implemented by some health-oriented shoe-making companies that are aware of the need for dual-function high heels. Among them are Mime et Moi in Germany and Camileon Heels in the USA (Volusion, 2018). The Mime et Moi adjustable high heel implements Flexheel technology to pull the heel in and out to adjust the height. It was invented by Huber Christian and has been patented (Huber, 2018). In the Flexheel technology, the sole component comprises a front, a middle, and a rear sole portion as well as a mechanism (shank) for adjusting the sole curvature in a transition region A between the rear and the middle sole portion and a second mechanism for adjusting the sole curvature in a transition region B between the

front and middle sole portion (Fig. 4a). The mechanism comprises a rotatable supporting element provided in such a way that it may have a first angular position causing a first sole curvature in the transition region A and a second angular position causing a second sole curvature in the transition region B, wherein the first sole curvature is different from the second. Note that other mechanisms (shank) such as leaf springs can also be used in the sole, which are firmly connected to both the middle and the rear sole portion and the middle and the front sole portion to provide defined curvatures to the first transition A and the second transition region B, respectively. Fig. 4b shows the second embodiment of the shank. The supporting element (shank) 114 is formed by rails 114A and 114B, wherein one or more than two rails may also be used. Rails 114A and 114B extend along the middle sole portion 5, wherein the sole is not shown in the middle sole portions for better illustration of rails 114A and 114B. For example, rails 114A and 114B may be made of flat-rolled steel. Rails 114A and 114B provide a first hinge 601 by which the rear sole portion 4 is movably attached to rails 114A and 114B, and a second joint 602 by which the front sole portion 6 is movably attached to rails 114A and 114B. For this purpose, rails 114A and 114B may each comprise a first hole for receiving an axis of the first hinge 601 and a second hole for receiving an axis of the second hinge 602.

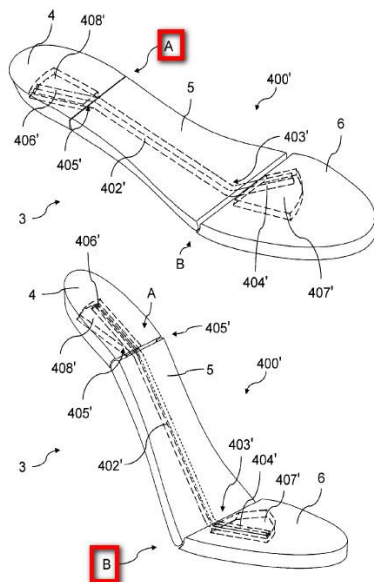

(a) Shank with sole in one embodiment.

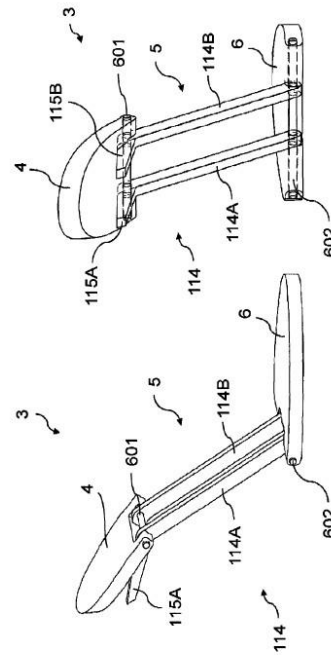

(b) Shank without sole in second embodiment

Fig. 4 Flexheel technology of US9980533



Fig. 5 Camileon Heels convertible high-heel shoe

The Camileon Heels patented (US8322053, Handel, et al., 2012) convertible high-heel shoe is shown in Fig. 5. The high heel (Stage 1 in Fig. 5) can be pulled outward and then bent forward to make the shoe flat (Stage 2 in Fig. 2). Some key figures of US8322053 are shown in Fig. 6. Converting the shoe from a high heel to a flat takes four steps. A sturdy support beam, 38 in Fig. 6 (b), is activated by a spring so that it can be pulled out and bent forward. Note that a high heel lift, 23 and 28, is secured so that the high heel extension piece, 24, and a low heel block, 22, can be protected. One thing worth noting is that the assignee of

US8322053 is Sean Flannery. However, its patent family member, TWI544877, shows that its assignee is Camileon Holdings, LLC. Putting these two assignees together in a Google search, one finds that Camileon Holdings LLC has assigned the patent right of the adjustable height high heels to Camileon Heels. It seems that the patent did not address the shank issue between high heel and flat. According to the drawing the shank should be underneath the arch region 18. When the heel is bent, the arch region should not be changed because the shank is embedded in it. It then will create a strange shape in the sole in the flat mode.

2.5 The 40 inventive principles of TRIZ

The 40 inventive principles of TRIZ were invented by Altshuller et al. (2005). It is reported that 40,000 patents were analyzed to extract the inventive principles. Each inventive principle has its rules of usage to help users apply it. For example, inventive principle 1 has three rules, as follows: 1. segment the object into independent parts; 2. divide the object so that it can be assembled easily; and 3. increase the degree of segmentation. The 40 inventive principles can be used alone or with a contradiction matrix (Altshuller, 1984). According to the literature, it is probably the most widely used tool in the TRIZ toolbox (Mann, 2002). The patent US8322053 is an example of inventive principles 1 (segmentation), 7 (nested doll) and 15 (dynamics). The heel is in one piece in the conventional high-heeled shoe. However, patent US8322053 segments the heel into two parts, a low heel block 22 and high heel extension piece 24 (the segmentation principle). Support beam 38 is imbedded into the low heel block 22 (the nested doll principle). A rotatable slotted pivot 54 makes the high heel extension piece 24 moveable along the slot (the dynamic principle).

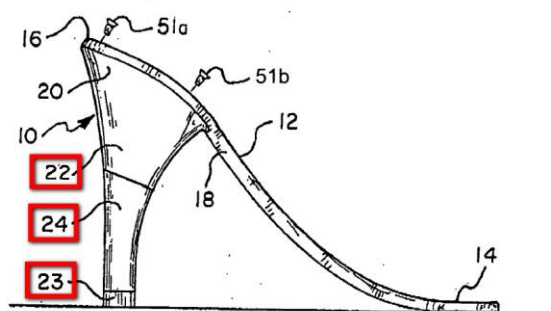

(a) High heel position

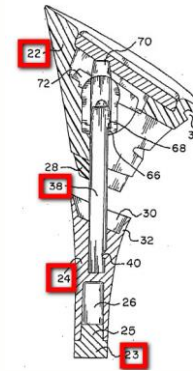

(b) Pull the heel downward

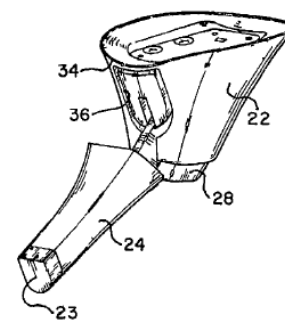

(c) Bend the heel forward to make a flat

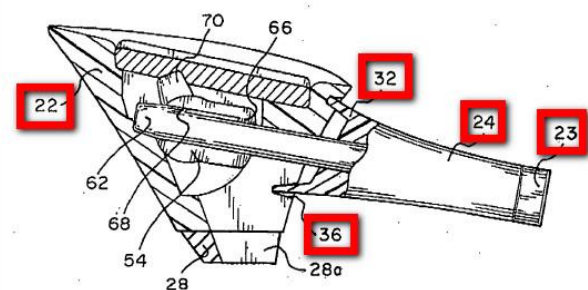

(d) Flat position

Fig. 6 Four stages of US8322053

3. Proposed high heel

After studying various patents on dual-function high heels such as CN205106566 (Ye, 2016) and WO2016/179675 (Roberto, 2016), as shown in Figs. 7 and 8, we have invented the proposed dual-function high heels. Concerning CN205106566, Fig. 7 shows that the way in which the two segmented parts of heel 3 and lift 2 join together is by means of a slot and plug. For WO2016/179675, however, the segmentation is more complicated. Fig. 8 shows that the invention re-

lates to a women's heeled shoe (C) with a shank (1) having a recess for a quick release screw (2), which allows the heel to be quickly removed and replaced (3), and which, together with a flexible and preferably PVC molded insole and an elastic junction (5) in the quarters (6) or vamp (7), allows a closed shoe (C) with a heel (3) to be converted into a flat shoe (8) and vice versa.

In the aspect of shank, the patents CN205106566 and WO2016/179675 did not mention about the issue of shank in different height of shank. In the CN20510656, no drawing of shank even was mentioned. In the WO2016/179675, shank was depicted in component 1 in Fig. 8. Since the shape of shank cannot be changed, it is hard to believe how the shoes can be converted from high heel to flat.

These two patents suggest the use of a segmented heel to solve the flat and high heel problem. They both apply principle 1 of the 40 inventive principles: segmentation. Two segmented parts join together by means of a slot and plug. Interested readers can refer to those patents. Our method of joining the parts is by thread and screw. A prototype has been made to test its validity, as shown in Fig. 9. Our contribution to making the proposed high heel is to use 3D printing to make the high heel support, a middle heel, a high heel, and a lift (the black pieces in Fig. 9). After making the heel support, heel and lift, a thread and screw are installed in the heel and lift respectively. Note that this sample adjustable high heel is specially made for a model.

The support is made by 3D printing overlaid with leather. Within the support, a bored hole with a thread is made. The heel is also made by 3D printing overlaid with glassy decoration. A bolt with a thread is put into the heel and a washer is inserted in it. The lift is used to protect the wear from the ground and a washer is inserted in it. The adjustable high heel has three modes: high mode, middle mode, and flat mode. When the adjustable high heel is in the high mode, it works just like an ordinary high heel. The support is connected to the high heel, which is connected to a lift. Then it can be switched to middle mode by changing the high heel to the middle heel. Lastly, a flat shoe can be made by taking out the middle heel. The support is connected directly to the lift.

Fig. 10 shows a magnified image of the high heel, revealing the support, heel, and lift. Note that the support is designed to fit the insole of the high heel and its

three-view engineering drawing is shown in Fig. 11, where a hole is bored through the support for receiving the bolt with thread.

Black washers are inserted in the middle and high heels and lift to secure their connection to the support, as shown in Fig. 12. Fig. 13 shows that the heels and lifts are kept in a fountain pen case when not in use. Lastly, a female college student was invited to help prove its utility, as shown in Fig. 14.

In order to make a complete design, the prototype picture of flat shoes is taken and inserted into Rhino for surface modeling to construct the 3D computer model. Its design and specification are depicted in Figs. 15–17. The shoe is a length of 230 mm, width of 77 mm, and height of 50 mm. The height of the top lift is 10 mm, and the height of the vamp is 14 mm. The distance between the supporting points in the out sole and top lift is 130 mm. The heel base is a disc 12 mm in diameter with a heel base size (HBS) of 1.13 cm². Luximon et al. (2015) showed that high-heeled shoes with a small HBS do not provide stable support, particularly on a small slope angle.

The computer model is drawn in Rhino for surface modeling with plugged-in utility of T-spline for Rhino. As shown in Fig. 17, the computer model is almost identical to the prototype. In order to show the match between the computer model and the prototype image, a wireframe model is displayed in top and left views.

Normally, an iron-like metal is embedded within the two supporting points in the out sole and top lift to support the weight of the user, as shown in the red lines in Figs. 18 and 19. As shown in Fig. 19, for different heel heights in conventional high-heel shoes, the structure of the shank is different. Thus, it is impossible to put the same shank into high-heel shoes with different heel heights. This poses a challenge for adjustable high heels, since there is only one shank for different heel heights. The shank normally is made of iron/steel plate and is rigid. When the high heel is changed to a different height, it changes the position of the shank, and the shank is no longer fitted to the foot comfortably. Thus, a technical contradiction occurs. When wearing high heels, the shank needs to be rigid; however, when changing from high heels to flats, the shank needs to be soft.

The problem is solved by using a different position embedded within the shank. If we shift the shank to the heel side and change the shape of the shank from an S shape to a curve with a large curvature like the one marked in yellow in Fig. 20, then the contradiction is solved. Note that in this design even the heel height is increased, and the shank will just be lifted on the right without changing the shape of the shank. Contrary to the conventional shape of the shank, the new shank design can fit into different heel heights.

To make a completion, a computer model is drawn for the middle heel and high heel following the procedure of flat shoes, as in Figs. 21 and 22. Note that the heights of middle heel and high heel are 10 mm and 20 mm, respectively. Looking carefully at Figs. 21 and 22, the heel for the middle-heel and high-heel shoes is tilted at 85 and 77.3 degrees, respectively, because the shank is fixed in shape and size. When the heel is increased by 10 mm with the insertion of the middle heel, the support will be lifted by 10 mm, with an effect that the support is somewhat rotated about the left supporting point. Note that in the middle-heel shoes the left supporting point is 128 mm away from the right supporting point underneath the top lift. This rotation effect causes the heel to tilt 85 degrees. As the height of the heel in high-heel shoes increases to 20 mm, the rotation effect becomes larger, which causes the heel to tilt 77.3 degrees.

It appears that the tilting of the heel is not good for users when walking because it causes instability. But through the experiment of the female model, the middle heel can be used without any problem in walking. However, the high-heel shoes can cause slowed-down walking. If we use the aspect of the shank to compare the four patents and the proposed adjustable high heel, with the wisdom of hindsight, it is easy to see the differences between them. Their differences are shown in Table 1. The design process is shown in Fig. 23.

In sum, the identified problem is the technical contradiction of shank. The research objective is to develop the adjustable high heel in simpler version without carrying additional heels. The development procedure starting with patent search to find out four patents and compare their difference in table 1, then use inventive principle to solve the problem. The used theories or techniques for generation of design alterna-

tives is shown in the design principle in Fig. 23. The generated design alternatives examination or evaluation is dealt by three designs in our proposal as shown Figs. 15, 21 and 22. The evaluation is shown in Fig. 14 and table 1.

The inventive principle we use to solve the shank problem is principle 15, dynamics. Item (a) refers to changing the object (or outside environment) for optimal performance at every stage of the operation. In our case, whereas the conventional shank is in an S-shape located from the outsole to the heel, the new shank design shrinks back away from the outsole such that the heel can be adjusted. Of course, principle 1, segmentation, can be easily seen in the detachable heels.



(a) Disassembled stages of heel components

(b) Assembled stage of heel components

Fig. 7 Structure of heel components of CN205106566

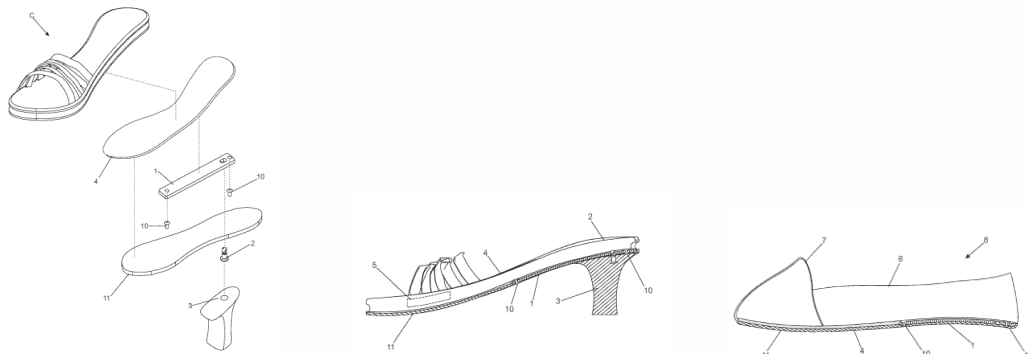

(a) Disassembled stages

(b) Assembled stage

(c) Flat shoe

Fig. 8 Structure of heel components of WO2016/179675



(a) Flat



(b) Middle heel



(c) High heel

Fig. 9 Proposed adjustable high heel



Fig. 10 Magnified version of Fig. 9(c)



Fig. 11 Support



Fig. 12 Heels and lift



Fig. 13 Case for heels



(a) Snapshot 1 of walking model



(b) Snapshot 2 of walking model

Fig. 14 Model wearing the shoes

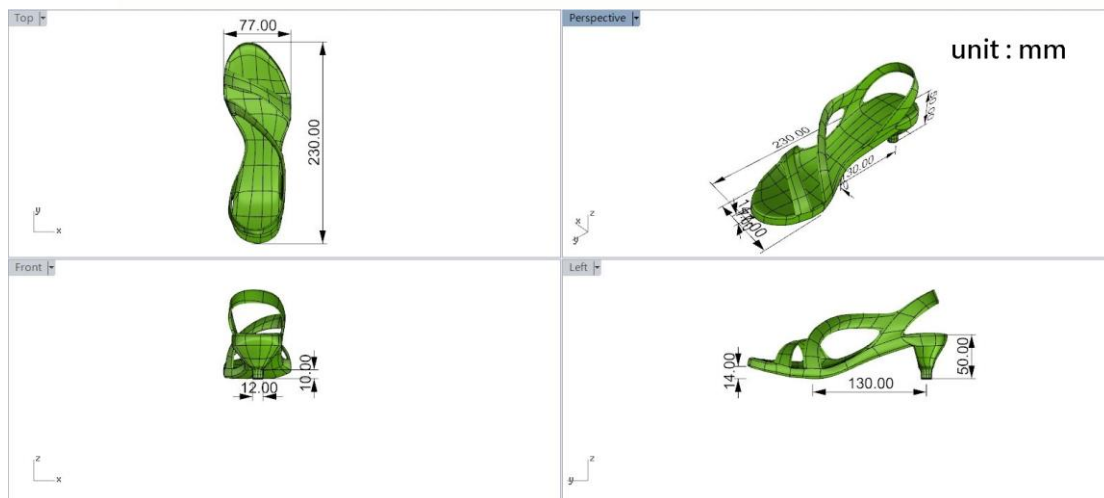

Fig. 15 Flat shoe design with specification

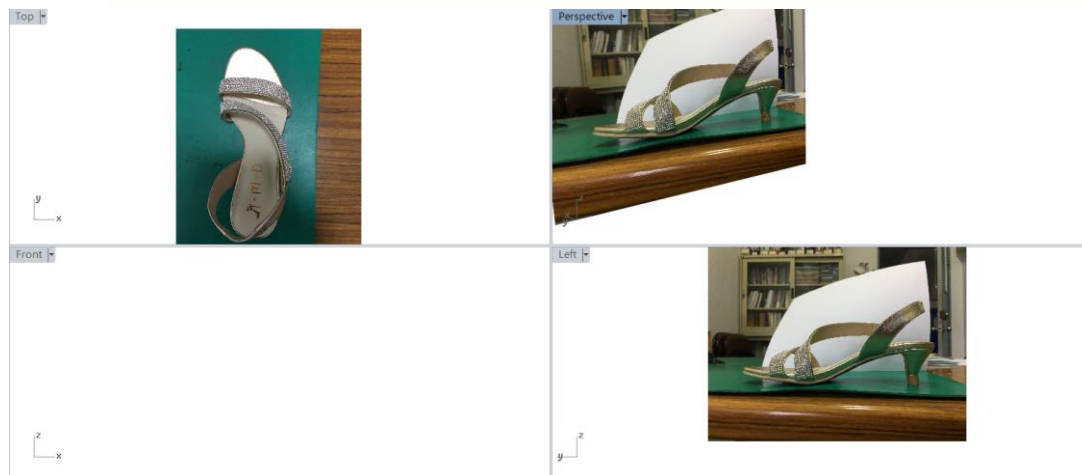

Fig. 16 Embedded with flat shoe images

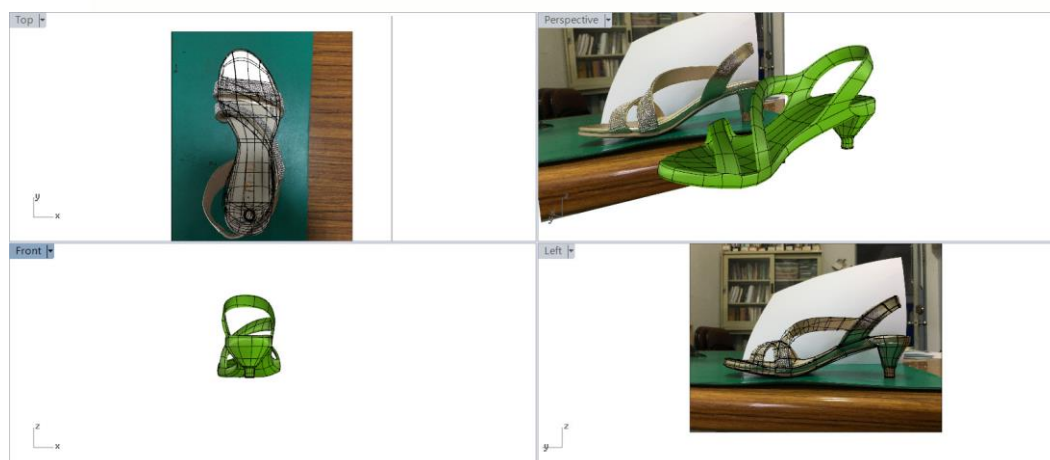

Fig. 17 Superimposed with flat shoe images and shoe model

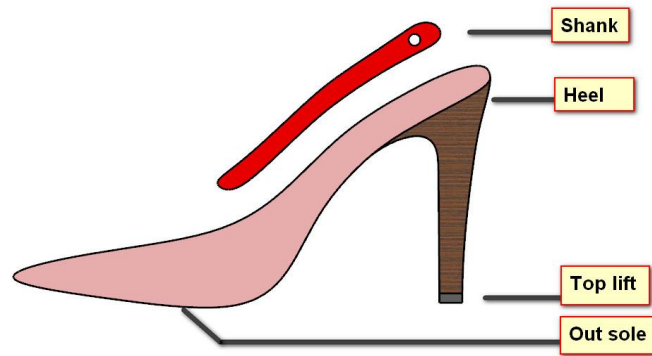

Fig. 18 Shank embedded in outsole-exploded view



Fig. 19 Shank embedded in outsole-for different heel height – taken from (Lee, 2012)

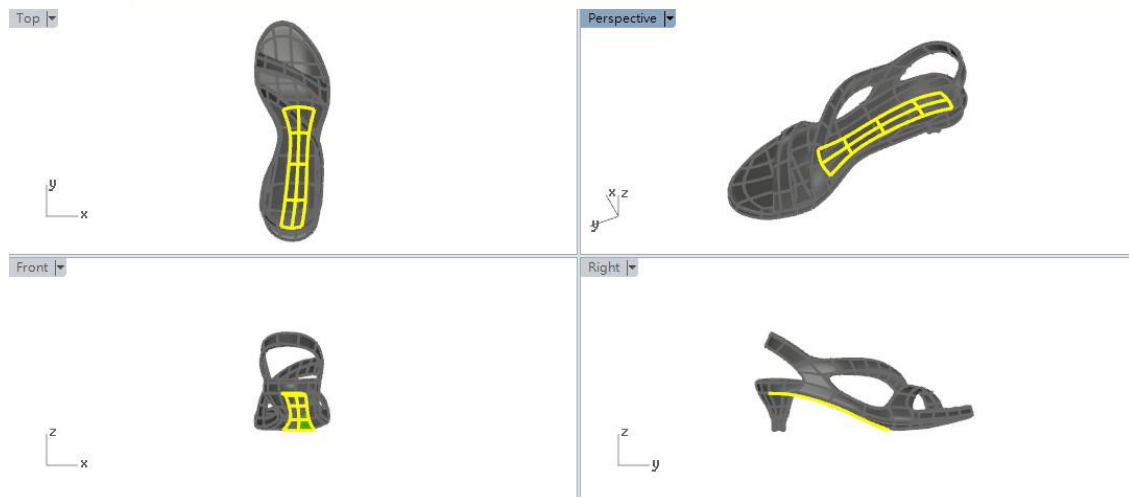

Fig. 20 New shank design

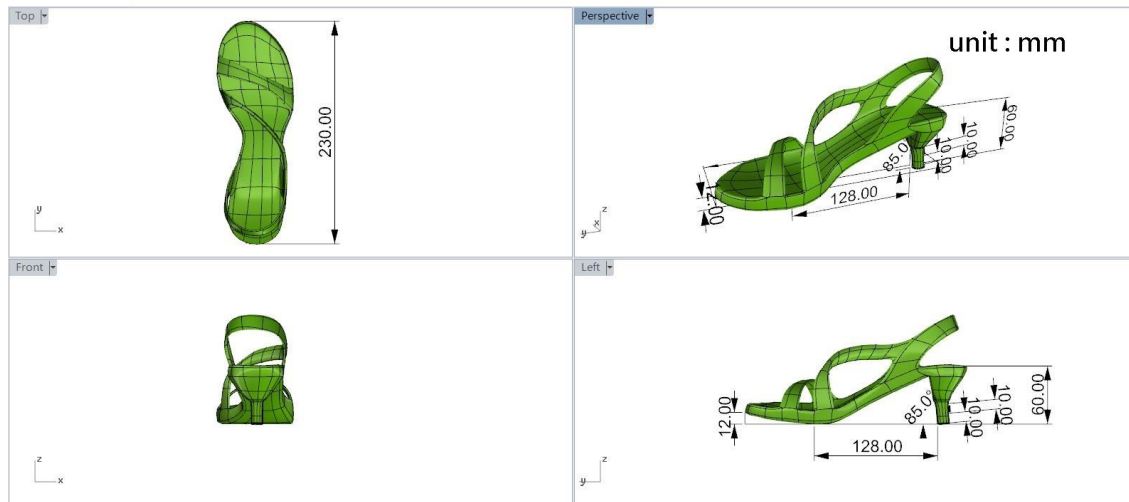
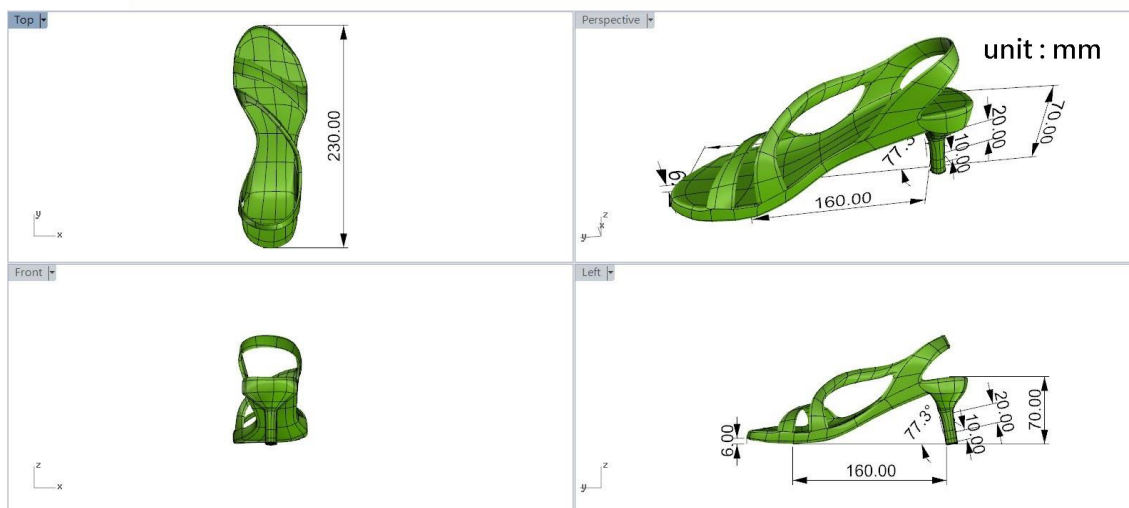

Fig. 21 Dimension of middle heel

Fig. 22 Dimension of high heel

Table 1. Comparison between the four patents and the proposed adjustable high heel

| Features Patents | Operating principles | Aspect of shank | Strengths and weaknesses |
|---------------------|---|--|---|
| US9980533 | The invention relates to a sole component for a shoe suitable for use with different heels. The sole component comprises a front, a middle, and a rear sole portion as well as a mechanism for adjusting the sole curvature in a transition region between the front and the middle sole portion. The mechanism comprises a rotatable supporting element provided in such | The supporting element (shank) is formed by two rails, 114A and 114B. Rails 114A and 114B extend along the middle sole portion 5, wherein the sole is not shown in the middle sole portions for better illustration of rails 114A and 114B. For example, rails 114A and 114B may be made of flat-rolled steel. Rails 114A and 114B provide | It fully solves the shank problem in different high-heel heights. However, the user needs to carry another pair of heels to replace the current ones. |

| | | | |
|-------------|--|--|--|
| | <p>a way that it may have a first angular position causing a first sole curvature in the transition region and a second angular position causing a second sole curvature in the transition region, wherein the first sole curvature is different from the second.</p> | <p>a first hinge 601 by which the rear sole portion 4 is movably attached to rails 114A and 114B, and a second joint 602 by which the front sole portion 6 is movably attached to rails 114A and 114B.</p> | |
| US8322053 | <p>A shoe has a sole with a toe, heel, and arch. A two-part heel has a low-heel block attached to the sole heel and includes a slot therein. A high-heel extension is attached to the low-heel block through a support beam having a substantially rectangular cross-section capable of limited axial and pivotal movement. The fit between the beam and the slot prevents rotational movement of the high heel about its axis. The high-heel extension can be pivoted between a first position where it underlies the low-heel block and a second position where it lies beneath the sole arch. The bottom of the low-heel block has a heel lift extending downwardly engaging the ground when the high heel is stowed. This low-heel lift is enclosed by a beveled edge at the top of the high-heel piece when it is vertical.</p> | <p>The shank is not discussed in the patent.</p> | <p>The shank seems to be solved by the commercial product from Camileon Heels. The strength of the product is that the user does not need to carry additional heels. The conversion between high heels and flats is done by bending the high-heel extension.</p> |
| CN205106566 | <p>The utility model discloses heel-detachable high-heeled shoes, including the shoes' body, heel, and locating part. The locating part includes a protrusion, whereas the heel includes a plug so that the plug and protrusion can be joined together. The locating part is joined with the support by a screw and thread. The user needs to carry different heel heights to exchange from a high heel and a flat.</p> | <p>The shank is not discussed in the patent.</p> | <p>The strength of the patent is that it is simple to change from high heels to flats. It divides the heel from the shoes, which is added to the locating part. The locating part is joined with the support by a screw and thread. However, the shoes can be unstable as flats because the upper will be tilted up, causing walking difficulty.</p> |

| | | | |
|---------------------------|---|---|--|
| <p>WO2016/179675</p> | <p>The invention relates to a woman's heeled shoe (C) with a shank (1) having a recess for a quick-screw fastener (2), which allows for quickly removing and replacing the heel (3), and which, together with a flexible insole (4), preferably a PVC molded insole, and an elastic junction (5) in the quarters (6) or vamp (7), allows a closed shoe (C) with a heel (3) to be converted into a flat shoe (8) or a sandal-like shoe (C) with a heel (3) to be converted into a flat sandal (9), for example, or vice versa.</p> | <p>The shank (1) is mentioned in the patent. However, its effect on different high-heel heights is not addressed.</p> | <p>The strength of this patent is that it contains an elastic junction (5) in the vamp to provide flexibility in the vamp when converting from high heels to flats. However, the shank problem is not solved.</p> |
| <p>Proposed high heel</p> | <p>The high heel has a shank with a curved shape covering the middle sole and part of the rear sole, but not the front sole. In this way, the shank can be fitted into different high-heel heights. In addition, a simple screw and thread are used to join the support and the heel without the locating part, as in CN205106566. It is also different from WO2016/179675 in that the quickscrew fastener (2) and part (11) are eliminated. The shank in our design is also different from that of WO2016/179675 in that our shank has a curved shape, whereas the shank (1) in WO2016/179675 looks like a straight bar.</p> | <p>The shank is fully addressed to accommodate different high-heel heights.</p> | <p>The strength of our design is that it is simple. The user does not need to carry additional heels. All the accessories are put in a pen case that is easy to carry. The drawback of the design is that in the high heel the heel is tilted to 77.3 degrees due to the influence of the shank on the heel.</p> |

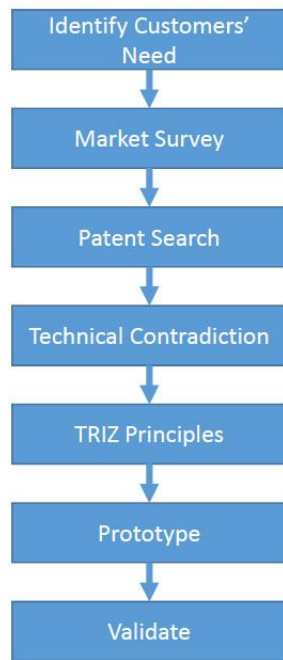

Fig. 23 Design principle of high heel

4. Conclusion

Dual-function high heels provide a useful function. Changing from flats to high heels and vice versa indeed creates a lot of convenience during the work and play of career women. In this paper, three types of high heels are mentioned: Skywalker, the Mime et Moi high heel with innovative height adjustment, and the Camileon Heels convertible high-heel shoe. Only the last two have been put on the market. The technologies of the last two are examined. Mime et Moi high heel uses FlexHeel technology to solve the shank problem in that the shank is broken down in three parts so that different curvatures can be made in the front and rear region of the sole. A key feature to accommodate the different height of high heel. As for the Camileon Heels, it bends the high heel extension so that high heel can be converted to flat in one clip. However, nothing is done on the matter of shank.

To invent a new high heel, a study of the patents was made and patents WO2016/179675 and CN205106566 are referred to in this work. These two patents suggest the use of a segmented heel to solve the flat and high heel problem. Principle 1, segmentation, of the 40 inventive principles is applied. Concerning CN205106566, two segmented parts are joined together by means of a slot and plug. In addition, a locating part is used to join the support and heel. Our method of joining the parts is by thread and screw and the locating part is eliminated. Our design is different from WO2016/179675 in that quickscrew fastener (2) and

part (11) are eliminated. The shank in our design is also different from that of WO2016/179675 in that our shank is a curved shape whereas the shank (1) in WO2016/179675 looks like a straight bar.

A prototype has been made to test its validity. Our contribution in making the proposed high heel is to use 3D printing to make the high heel support, a middle heel, a high heel, and a lift. After making the support and heel, a thread and screw are installed in the support and heel respectively. On the top of the middle and high heels and lift, a black washer is inserted to secure their connection to the support. The heels and lifts are kept in a fountain pen case when not in use. Lastly, a female college student was invited to help prove its utility.

Another contribution of this paper is that it addresses the issue of the shank. The shank normally is made of iron/steel plate and is rigid. When the high heel is changed to a different height, it changes the position of the shank, and the shank is no longer fitted to the foot comfortably. Thus, a technical contradiction occurs. When wearing high heels, the shank needs to be rigid; however, when changing from high heels to flats, the shank needs to be soft. The contradiction is solved by changing the shape of the shank. We change the shape from the S shape to a curved surface located from the middle sole to the rear sole. Our design does not completely solve the shank problem, because it raises another issue of the heel tilting in high heels at 77.3 degrees. Further research needs to be conducted on this matter.

5. References

- Altshuller, G., Shulyak, L. & Rodman, S. (2005). *40 Principles: TRIZ Keys to Technical Innovation*, Extended ed., Technical Innovation Center.
- Altshuller, G. (1984). *Creativity as an Exact Science: the Theory of the Solution of Inventive Problems*, Philadelphia, PA: Gordon and Breach.
- Baaklini, E., Angst, M., Schellenberg, F., Hitz, M., Schmid, S., Tal, A., Taylor, WR. & Lorenzetti, S., (2017). High-heeled walking decreases lumbar lordosis, *Gait & Posture*, 55, 12-14.
- Borchgrevink, GE., Viset, AT., Witsø, E., Schei, B. & Foss, OA., (2016). Does the use of high-heeled shoes lead to fore-foot pathology? A controlled cohort study comprising 197 women, *Foot and Ankle Surgery*, 22(4), 239-243.

- Filho, T., Dezzotti, NR., Joviliano, EE., Moriya. T. & Piccinato CE., (2012). Influence of high-heeled shoes on venous function in young women, *Journal of Vascular Surgery*, 56(4), 1039-1044.
- Goonetilleke, R. S. & Weerasinghe, T. W., (2012) Footbed design. In R. S. Goonetilleke (Ed.), *Science of Footwear*, (pp. 279-290). Boca Raton, FL: CRC Press.
- Huber, C. (2018). *Sole part*, US Patent No. US9980533.
- Kausch, S. (2018). Flexheel GmbH, Retrieved May 20, 2017, from <https://www.exist.de/DE/Campus/Gruendergeist/EXIST-Erfolge/Flexheel-GmbH/inhalt.html>.
- Kouchi, M., (2012) High-heeled shoes. In R. S. Goonetilleke (Ed.), *Science of Footwear*, (pp. 261-277). Boca Raton, FL: CRC Press.
- Lee, C. (2012), *The Design and Creation of Custom-made High Heel Shoes*, Master thesis of Graduate school of architecture and product design, Shih Chien University, Taiwan.
- Luximon, A. (2013), *Handbook of Footwear Design and Manufacture*, Woodhead Publishing.
- Luximon, Y., Cong, Y., Luximon, A. & Zhang, M., (2015). Effects of heel base size, walking speed, and slope angle on center of pressure trajectory and plantar pressure when wearing high-heeled shoes, *Human Movement Science*, 41, 307-319.
- Maia Research, (2018), *Global High-Heeled Shoes Industry Market Research Report*.
- Mann, D. (2002). *Hands-on Systematic Innovation*, CREAX Press.
- Moore, J., Lambert, B., Jenkins, G., McGwin, G., (2015). Epidemiology of High-Heel Shoe Injuries in U.S. Women: 2002 to 2012, *The Journal of Foot and Ankle Surgery*, 54(4), 615-619.
- Morris, P. H., White, J., Morrison, E., Fisher, K., (213). High heels as supernormal stimuli: How wearing high heels affects judgements of female attractiveness, *Evolution and Human Behavior*, 34, 176-181.
- Roberto, S. (2016). PCT patent, No. WO2016179675. Retrieved from Espacenet.
- The history of high heels, (2018, August 10). Youtube, Retrieved April 10, 2017, from <https://www.youtube.com/watch?v=LSvW1yQCeR0>.
- Tsagari, D. (2014). New High Heel Shoe Instantly Turning Flat Can Change Women's Lives. Retrieved June 12, 2017, from <https://greece.greekreporter.com/2014/08/28/new-high-heel-shoe-instantly-turning-flat-can-change-womens-lives/>.
- Volusion (2018). Camileon Heels, Retrieved May 20, 2017, from <http://www.camileonheels.net/>.
- Wiedemeijer, M., Otten, E., (2018). Effects of high heeled shoes on gait. A review, *Gait & Posture*, 61, 423-430.
- Wikipedia (2018), High-heeled shoe, Retrieved August 12, 2017, from https://en.wikipedia.org/wiki/High-heeled_shoe.
- Ye, Z. (2016). China Patent No. CN205106566. Retrieved from China Patent Database.

AUTHOR BIOGRAPHIES



Jyhjeng Deng has been a Professor at DaYeh University in Taiwan since 1994. He received his Ph.D. degree in Industrial Engineering from Iowa State University. He is currently the Chair of the Industrial

Engineering and Management Department at DaYeh University and a board member of the Society of Systematic Innovation. His areas of interests include systematic innovation, including TRIZ and patent analysis and circumvention, and computer graphics in product design.



Teng-Hsuan Lin graduated from the technology management department of Chung Hua University with both his bachelor and master degrees. He used to be the Purchasing and Management Manager of Changyuan Technology Co.,

Ltd., the Purchasing and Management Manager of Chengtai Co., the Quality Assurance and Development Manager of Liangfei Company, and the Quality Assurance Manager of Xinglianfeng Co., Ltd. In 1978, he was elected as a Taichung city and a national model worker. Currently he is studying for a doctoral degree in environmental engineering department at Dayeh University.

The Patent Map of a Measuring Cup

Jyhjeng Deng* and Juin Yi Lee

Industrial Engineering and Management Department, DaYeh University, Taiwan

*Corresponding author, E-mail: jdeng@mail.dyu.edu.tw

(Received 11 September 2017; final version received 30 January 2019)

Abstract

People use measuring cups to measure the required portion of liquid when making bread. Traditional measuring cups have indicia marked on the side such that they are difficult to read when the user is unable to bend his or her body or hold the cup firmly in the hand. However, the OXO measuring cup overcomes this problem by having at least one ramp formed radially inward on the inside surface of the measuring cup. The indicia on the upward surface of the ramp allow the user to look downward into the measuring cup, thereby eliminating the need to look horizontally at the cup at eye level. The design is shown in patent US6263732. This article carries out a further analysis of this invention by tracing its forward and backward citations to build a simple patent map of technology development of the measuring cup. Three patents, namely US4073192, US4566509, and US5588747, are chosen from 16 backward citations, while another three patents, namely US7306120, US8517219, and US9354098, are chosen from 25 forward citations. The analysis of these three backward citation patents shows that although various functions such as adjustable volume, thermometer, and so on can be added to the measuring cup, no measuring cup has ever discussed the issue of easy visibility as the OXO measuring cup does. In addition, three forward citations show that various methods have been invented to meet the need for easy visibility by using different structures such as a ramp or ladders. It is clear from the analysis that inventive principles 17, another dimension, and 32, optical change, are applied in those inventions. A trend of surface segmentation (Mann, 2002) can be found from US6263732 to US9354098, where the ramp in US6263732 is a flat surface, whereas US9354098 uses a more advanced design in which the ramp is a 3D protrusion, allowing the reverse side of the measuring cup to be used to measure the quantity of fluid too.

Keywords: Backward citation, Forward citation, Inventive principles, Trend of surface segmentation.

1. Introduction

The patent map was first proposed by the Japan Patent Office in 1997 to assist in using patent information in industry (Japan Patent Office, 2000). There are many kinds of patent maps, including tree maps, time series maps, portfolio maps, matrix analysis, three-dimensional bar graphs, matrix charts, bubble graphs, bar graphs, and pie graphs. The purposes of patent maps are to understand the overall state of a technology field, identify technological changes, seek business opportunities, know the properties of applicants, and deal with the globalization of business. As TRIZ researchers, we are more interested in finding out technological changes. From there we can obtain in-

sights into the trend of the evolution (Mann, 2002) of a particular product or industry.

Measuring cups are used in many applications ranging from food preparation to laboratory experiments. A common drawback is that it is necessary for the user to lift the cup firmly to read the indicia. This problem was solved by the OXO measuring cup (OXO, 2017), which contains one ramp formed radially inward on the inside surface of the measuring cup. The indicia on the upward surface of the ramp allow the user to look downward into the measuring cup, thereby eliminating the need to look horizontally at the cup at eye level. The design is shown in patent US6263732 (Hoeting and Hoeting, 2001).

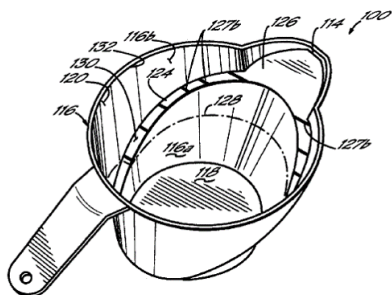

(a) Measuring cup in US6263732



(b) OXO measuring cup

Fig. 1 Measuring cup with a ramp on its inside surface

To study the trend of evolution of measuring cups, the citations of US6263732 in the European patent database (Espacenet Patent Search, 2017) are used to extract the related patents. The purpose of this paper is to demonstrate the procedure of creating the patent map in terms of technological changes. The trend of evolution of the measuring cup will be identified as well.

The rest of the paper is organized as follows: Section 2 provides a literature review of patent maps of technological changes. Section 3 describes the construction of the patent map and trend of evolution of the measuring cup. Section 4 concludes the paper.

2. Literature review

Global competition in the development of technology has caused continuous technological changes. In order to survive in this severe changing environment by accommodating these changes, companies need to be aware of patent maps which are produced by analyzing patent information. There are several kinds of patent maps related to technological changes (Japan Patent Office, 2000).

1. Changes in the relation between the number of applications and the number of applicants

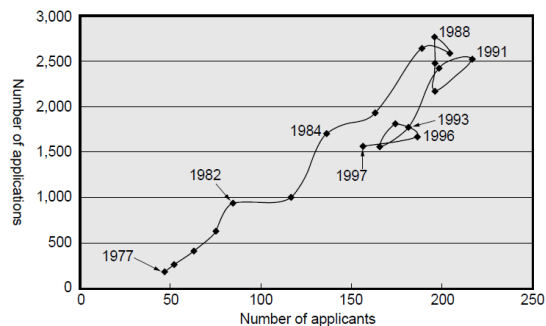

Fig. 2 Line chart of number of applications versus number of applicants

Fig. 2 shows the relationship between the number of applicants and the number of patent applications for optical disks for each of the years from 1977 to 1997. There are four periods in Fig. 2. The period from 1977 to 1988 is a time of growth. Then the period from 1988 to 1991 is the first period of stabilization. Next the period from 1991 to 1994 is a period of decline. Lastly, the period from 1994 to 1997 is the second stabilization period.

2. Map portraying the degree of maturity of a technology field

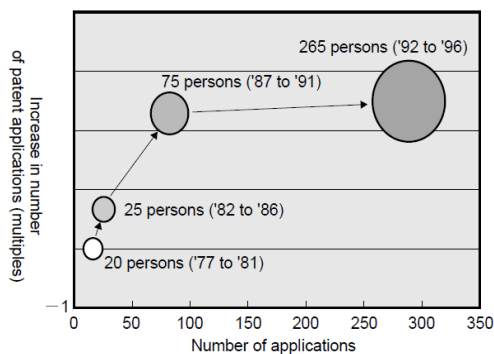

Fig. 3 Bubble chart of incremental change in the number of applications

Fig. 3 shows the ratio of the increase in the number of patent applications during a later period relative to an earlier period plotted on the vertical axis and the total number of patent applications within a certain period plotted on the horizontal axis, with respect to the recycling of plant and animal waste into fertilizer. This indicates that starting after 1987 the number of companies and so on newly entering the industry is increasing each year and that the technology field is in the developmental stage.

3. Changes of technical contents

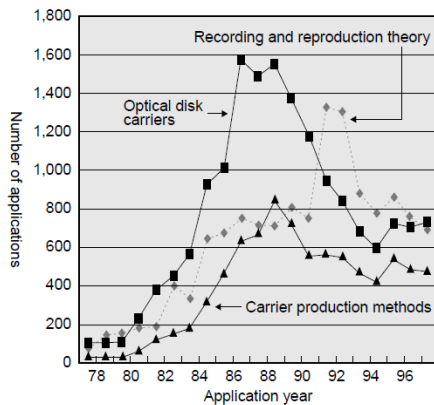

Fig. 4 Line charts of three major technological changes

Fig. 4 indicates the changes in the number of patent applications for the three major technologies that compose optical disks, namely "recording and reproduction theory", "optical disk carriers", and "carrier production methods". It can be seen from this figure that, after appearing to have reached a technically mature stage around 1988, development activity again accelerated in the area of the "recording and reproduction theory" around 1991, and as a result the technology entered a development stage for next-generation products.

4. Trends of problems in technological development

Map relating to dioxin decomposition of fluid bed incinerators

| Purpose | Dioxin decomposition only | | | | Cost reduction | | | | Improved maintenance | | | | Accommodation to fluctuations of refuse type and volume | | | | Heat recovery and others | | | |
|--|---------------------------|-------|-------|-------|----------------|-------|-------|-------|----------------------|-------|-------|-------|---|-------|-------|-------|--------------------------|-------|-------|-------|
| | 84-86 | 87-89 | 90-92 | 93-95 | 84-86 | 87-89 | 90-92 | 93-95 | 84-86 | 87-89 | 90-92 | 93-95 | 84-86 | 87-89 | 90-92 | 93-95 | 84-86 | 87-89 | 90-92 | 93-95 |
| Fluid bed combustion characteristics | ● | ● | ● | ● | ● | ● | ● | ● | ● | ● | ● | ● | ● | ● | ● | ● | ● | ● | ● | ● |
| Secondary combustion temperature control | ● | ● | ● | ● | ● | ● | ● | ● | ● | ● | ● | ● | ● | ● | ● | ● | ● | ● | ● | ● |
| Secondary combustion mixing control | ● | ● | ● | ● | ● | ● | ● | ● | ● | ● | ● | ● | ● | ● | ● | ● | ● | ● | ● | ● |
| Secondary combustion retention time | ● | ● | ● | ● | ● | ● | ● | ● | ● | ● | ● | ● | ● | ● | ● | ● | ● | ● | ● | ● |

● represents one patent.

Fig. 5 Matrix of purpose and function

Fig. 5 shows a trend in which patent applications were concentrated during the period from 1990 to 1995 in response to the announcement of guidelines by the Ministry of Health and Welfare. Although patent applications consist primarily of those in fields related to fluid bed combustion characteristics and secondary combustion mixing and temperature control, which have a direct effect on dioxin decomposition, from the 1980s to the present day, it can be seen that patent

applications relating to accommodation to fluctuations of refuse type and volume have been filed continuously.

5. Changes in influential industrial fields in technological development

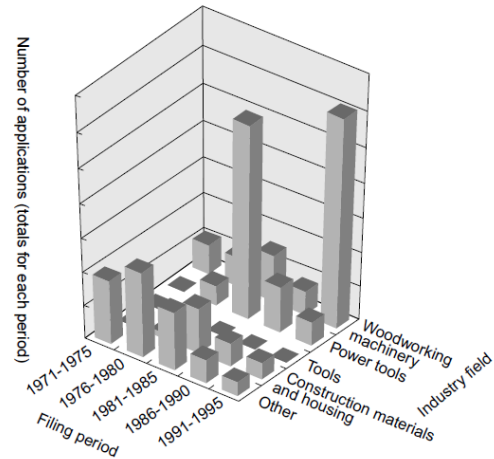

Fig. 6 Bar chart of various industry fields

Fig. 6 shows the changes in the respective numbers of patent applications by dividing those manufacturers ranked from first to tenth in the number of patent applications throughout the entire period into industry fields consisting of woodworking machinery, power tools, tools, construction materials, housing, and others with respect to rotary blade tenoning machines. In this study, a clear change in the leading industry field from power tools to woodworking machinery can be seen.

6. Map of technology development

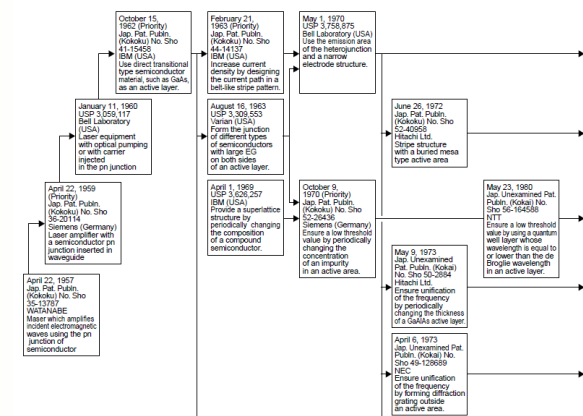

Fig. 7 Map of technology development for semiconductor lasers

Fig. 7 shows in part basic patents of semiconductor lasers in chronological order. It can be seen that the world's first semiconductor laser was invented by a Japanese researcher in 1957. Later, new devices were invented, led primarily by the US, and various inventions were added to enable laser excitation at low temperatures and eventually at room temperature. At the practical application stage, it can be seen that Japan has overcome technological problems including prevention of deterioration, unification of vertical mode, and reduction of the threshold value for excitation.

Only one paper addressing both patent maps and TRIZ could be found, although others may exist. The only one we found was done by Li, Atherton, & Harrison (2014), who compared the patent map and TRIZ in terms of purpose, logic, and outcome. However, only TRIZ technical contradictions were used to analyze the court case of infringement based on the conflicting parameters from different patents.

The reasons of literature review are summarized as follows. There are two parts of literature review. The first is for the patent maps of technological changes. The second is the only paper we found in the literature. It regards the TRIZ and patent map. The content of the literature review shows that there are several methods to analyze the technological change. And we choose one them for convenience, map of technology development. As for the TRIZ and patent paper, it presents a novel method of patent mapping for visualizing conflicts between patent claims that incorporates the Theory of Inventive Problem Solving (TRIZ). The method uses TRIZ engineering parameters as the criteria for evaluating dissimilarities between patent claims, producing a visualization based on Multi-Dimensional Scaling (MDS) that can be compared with legal judgments. And this paper has nothing to do with technology change. The connection between literature review and the purpose of the study is that although there are some papers on the patent technology change and TRIZ individually, there is no case study on both patent technology change and TRIZ. Thus it ushers the opportunity for us to do the study in this area.

3. Construction of patent map

The forward and backward citations of the European Espacenet patent database were used to establish the patent map of technology development. US patent US6263732 was used as a seed to retrieve its backward citations, and there were 16 patents, as shown in Figs. 8 and 9. Note that cited documents were used to indicate the backward citations in Fig. 9. The meaning of a backward citation is the reference patents that appeared before patent US6263732. The reference point is its filed date, May 18, 1999. Three patents, namely US4073192 (Townsend, 1978), US4566509 (Szajnz, 1986), and US5588747 (Blevins, 1996), were chosen from 16 backward citations. Similarly, forward citations were applied to US patent US6263732, and 25 patents were available. The result is shown in Fig. 10. The meaning of forward citation is the reference patents that appeared after patent US6263732. Another three patents, namely US7306120 (Hughes, 2007), US8517219 (Prince, 2013), and US9354098 (Breit and Kushner, 2016), were chosen from the 25 forward citations. The characteristics of these seven patents are analyzed and shown in Table 1. From Table 1, a map of technology development is shown in Fig. 11.

Three related patents were selected from both backward and forward methods based on their uniqueness. This means that other un-selected patents are quite similar to the selected one in terms of functions. In our case, the functions of backward citation are: to adjust the volume (US4073192), extend the measuring function to a cap of a bottle (US4566509), or combine a temperature-measuring function with a cup.

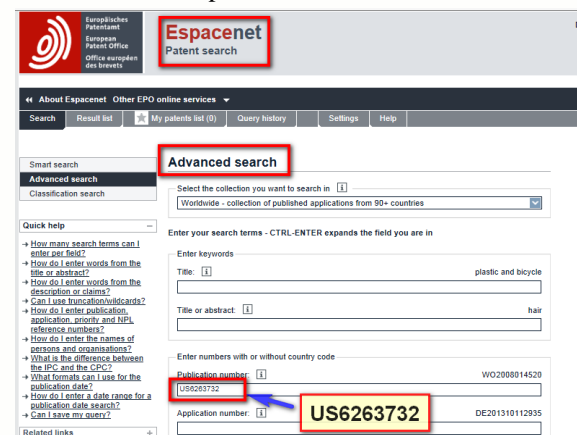

Fig. 8 Espacenet patent search

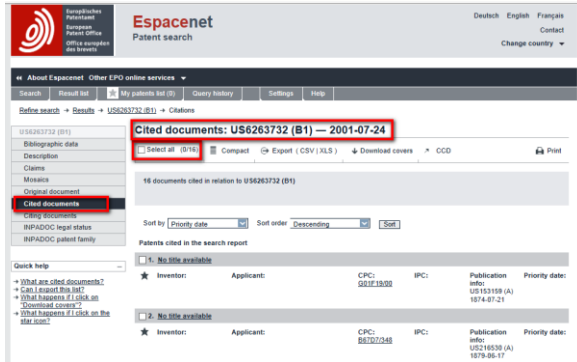
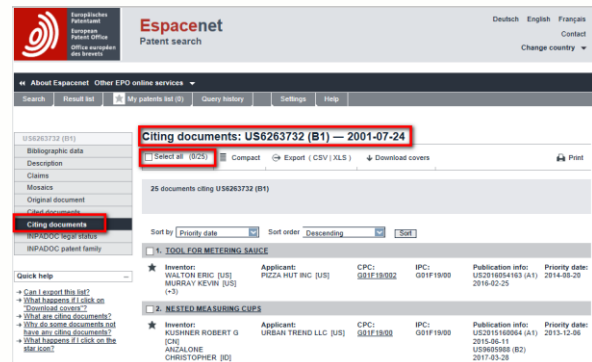
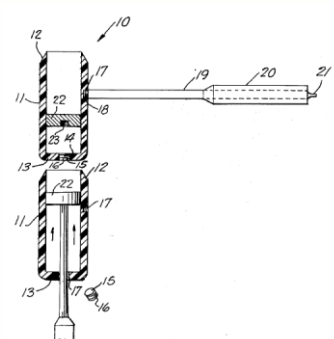
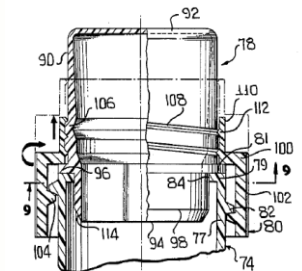
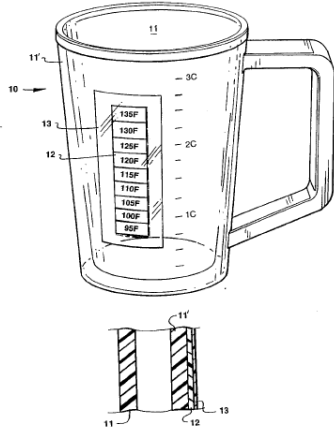
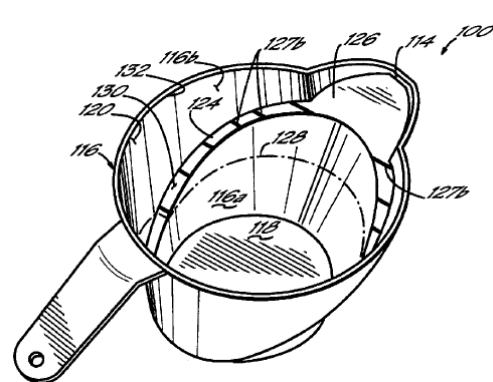
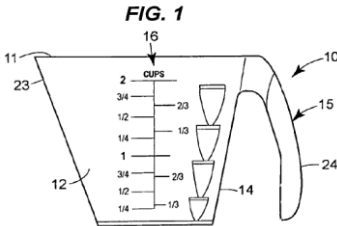
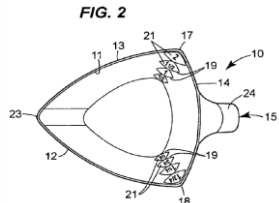
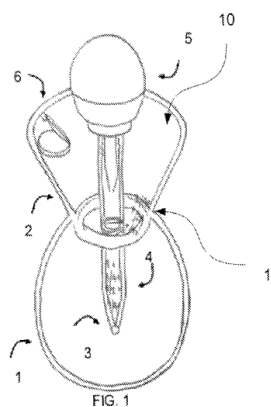
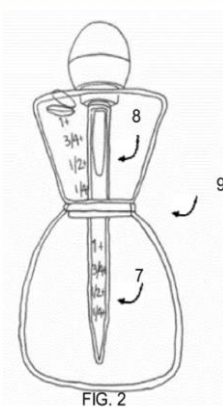
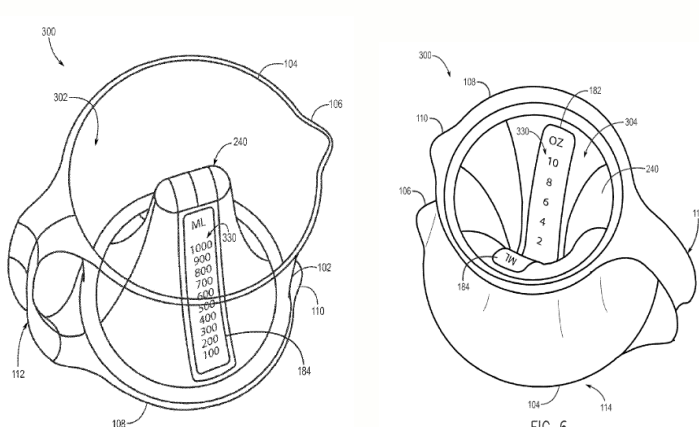

Fig. 9 Sixteen patents in backward citations

Fig. 10 Twenty-five patents in backward citations

Table 1 Selected backward and forward citations of US6263732

| No. | Patent number | Filed date | Technical description and drawings |
|-----|---------------|------------|--|
| 1 | US4073192 | 1976-06-16 | <p>An adjustable-volume measuring cup in which the body of the cup is formed of clear plastic having a threaded opening in the axial center of the bottom thereof, closed with a removable screw.</p>  |
| 2 | US4566509 | 1984-07-09 | <p>In accordance with this invention, a closure unit is provided which includes a measuring cup wherein the body of the measuring cup is provided with a flange which is seated on and sealed with the neck finish of a container. The closure unit also includes a ring member which engages the flange and clamps it against the container neck finish when a skirt of the ring member is interlocked with the neck finish. In this arrangement, the measuring cup telescopes within the container and any residue within the measuring cup after usage runs only into the interior of the container.</p>  |

| | | | |
|---|-----------|------------|--|
| 3 | US5588747 | 1995-01-05 | <p>A measuring cup with a thermometer mounted on an exterior surface thereof for measuring the temperature of a liquid prior to placing it in the cup. The cup can be used in many operations involving a liquid having a critical temperature requirement. One such operation is bread-making, in which water, once it has been warmed to a desired temperature, is added to yeast or, alternatively, to a flour mixture containing yeast. To use the cup in bread making, the cup is placed under a stream of warm water, and when the thermometer indicates that the water has reached the desired temperature, a measured amount of the water is added to the cup.</p>  |
| 4 | US6263732 | 1999-05-18 | <p>A measuring cup has one ramp formed radially inward on the inside surface of the measuring cup sidewall. The ramp rises from near the bottom edge of the sidewall to near the top edge of the sidewall. The indicia on the upwardly directed surface of the ramp allow the user to look downward into the measuring cup to visually detect the volume level of the content of the measuring cup, thereby eliminating the need to look horizontally at the cup at eye level.</p>  |

| | | | |
|---|-----------|------------|---|
| 5 | US7306120 | 2004-07-15 | <p>An improved measuring device is disclosed which comprises a bottom wall connected to at least three sidewalls, which, in turn, are connected together to form an open top and at least three corners. One of the corners forms a spout and at least one of the other corners is connected to a plurality of vertically spaced steps inside the cup. Each step has a horizontal upper surface and the horizontal surfaces of each step are marked with volumetric indicia. In this way, as the user fills the container with material, either liquid or solid, the user is confident that the correct volume has been achieved when the volumetric indicia located on the horizontal surface of the selected step begin to be covered with material.</p> <div style="display: flex; justify-content: space-around; align-items: center;">   </div> |
| 6 | US8517219 | 2010-06-28 | <p>A measuring tubing with its lower opening is inside the lower portion of the lower base member. Then draw a measured amount of liquid into the tube area via a suctioning means. Next, verify that the proper amount of liquid is drawn on a printed indicia on the sides of said measuring tubing into the upper cup area. Turn the bottle upside down, letting the liquid flow out of a upper lateral opening of said measuring tubing. Plac the bottle back into an upright position, and pouring the liquid out into the desired area.</p> <div style="display: flex; justify-content: space-around; align-items: center;">   </div> |

| | | | |
|---|-----------|------------|--|
| 7 | US9354098 | 2013-12-06 | <p>A measuring cup may have volumetric indicia printed along the upper and lower surfaces of a reference member placed near a central portion of a space encircled by a sidewall of the measuring cup. The volumetric indicia may be viewable from above the measuring cup when the cup is placed on a horizontal countertop or work surface. When inverted, the volumetric indicia printed along the lower surface of the reference member may likewise be viewable from above. In essence, the measuring cup contains two receptacles for measuring volumes of substances. One receptacle is accessible from the “top” of the measuring cup, while another receptacle is accessible from the “bottom” of the measuring cup. The reference member eliminates the need to raise the measuring cup to eye level to check the volume of substance.</p>  <p style="text-align: center;">FIG. 6</p> |
|---|-----------|------------|--|

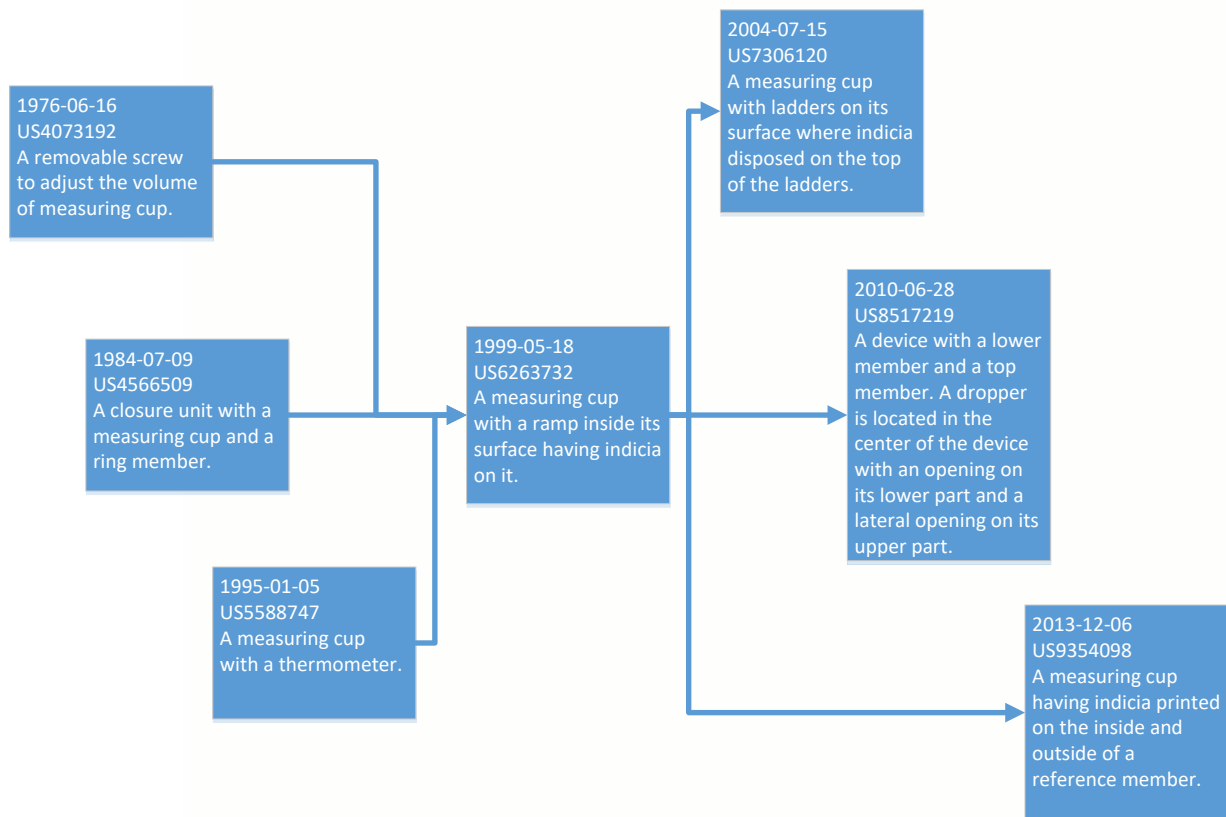

Fig. 11 Map of technology development for measuring cup

Fig. 11 shows that before the invention of patent US6263732, patents focused on ways to adjust the volume (US4073192), extend the measuring function to a cap of a bottle (US4566509), or combine a temperature-measuring function with a cup (US5588747). Then the function of easily readable indicia on the cup was incorporated into patent US6263732. Afterwards, various means were proposed to achieve the easy reading function such as using ladders (steps) on the inside surface of the cup (US7306120) and inserting a mound-like reference member in the middle of the cup (US9354098). In addition, the transparent material used in US6263732 was also applied in US8517219 to invent a device that could measure the liquid precisely without an additional part such as a spoon, as shown in its reference patent, US4192360 (Rodriquez, 1980). The trend of evolution of the measuring cup shows that once a long-sought solution to a problem is provided by an invention (US6263732), other inventors will try to use different means to solve the same problem. In our case, patents US7306120 and US9354098 solved the same problem as US6263732 did. These three patents take advantage of the inside surface of the measuring cup. They apply inventive principle 17, another dimension. A trend of surface segmentation (Mann,

2002) can be found from US6263732 to US9354098, where the ramp in US6263732 is a flat surface, whereas US9354098 uses a more advanced design in which the ramp is a 3D protrusion, allowing the reverse side of the measuring cup to be used to measure the quantity of fluid too.

To resolve the problem by forming a technical contradiction (Cameron, 2010), if we put the ordinary measuring cup on the table and stoop down to see the indicia at eye level, then we can see the scale precisely; however, we will get tired. So in this scenario, the parameter that is improved is the ability to see the scale precisely, which can be considered as parameter 28, measurement accuracy, while the parameter that is worsened is becoming tired, which can be considered as parameter 19, use of energy by a moving object. The contradiction matrix in Fig. 12 shows that the triggering inventive principles (IPs) are IP 3, local quality, IP 6, universality, and IP 32, optical changes. Retrospectively, the OXO measuring cup uses inventive principle 3, local quality (the ramp inside the surface), and inventive principle 32, optical changes

(transparent material such as Pyrex). Note that IP 17, another dimension, is not among the suggested IPs. Note also that IP 6, universality, was not used in the previous patents, so perhaps this inventive principle could be used to find a new solution.

Altshuller Matrix

| | |
|------------------------------|---|
| Parameter to improve | 28 - Accuracy of measurement |
| Undesired results (conflict) | 19 - Energy spent by moving object |
| Principles | 3 Local quality [12] 6 Universality [20] 32 Optical changes [9] |

Select the parameter you wish to improve, and the feature that thereby requires a trade-off. The suggested group of inventive principles to use will be shown above!

Fig. 12 Contradiction matrix for measuring cup

4. Conclusion

A patent map is very useful for keeping track of technological developments and we have applied it to the measuring cup. The task started with the OXO measuring cup described in the patent US6263732. Three patents were extracted using the backward citations of US6263732 and three were extracted using the forward citations. They are US4073192, US4566509, US5588747, US7306120, US8517219, and US9354098, respectively. A map of technology development based on these seven patents is established. Analysis of the map shows that before the invention of patent US6263732, the patents focused on ways to adjust the volume (US4073192), extend the measuring function to a cap of a bottle (US4566509), or combine a temperature-measuring function with a cup (US5588747). Then the function of easily readable indicia on the cup was incorporated into patent US6263732. Afterwards, various means were proposed to achieve the easy reading function such as using ladders (steps) on the inside surface of the cup (US7306120) and inserting a mound-like reference member in the middle of the cup (US9354098). In addition, the transparent material used in US6263732 was also applied in US8517219 to invent a device that could measure the liquid precisely without an additional part such as a spoon, as shown in its reference patent, US4192360. In our case, patents US7306120 and US9354098 solved the same problem as US6263732 did. These three patents take advantage of the inside of the surface of the measuring cup. They apply the application of inventive principle 17, another dimension. A trend of surface segmentation (Mann, 2002) can be found from US6263732 to US9354098,

where the ramp in US6263732 is a flat surface while the ramp in US9354098 is advanced to 3D protrusion so that the reverse side of the measuring cup can also be used to measure the quantity of fluid too.

To resolve the problem by forming a technical contradiction, if we put an ordinary measuring cup on a table and stoop down to see the indicia at eye level, then we can see the scale precisely but we will get tired. So in this scenario, the parameter that is improved is parameter 28, measurement accuracy, while the parameter that is worsened is parameter 19, use of energy by a moving object. The contradiction matrix shows that the triggering inventive principles (IPs) are IP 3, local quality, IP 6, universality, and IP 32, optical changes. Retrospectively, the OXO measuring cup uses inventive principle 3, local quality (the ramp inside the surface), and inventive principle 32, optical changes (transparent material such as Pyrex). Note that IP 17, another dimension, is not among the suggested IPs. Note also that IP 6, universality, was not used in the previous patents, so perhaps this inventive principle could be used to find a new solution.

The conclusion will not be too much different from the ones derived. Because the main conclusion is that before the invention of US6263732, the patents focus on various functions of cup instead of easy reading. After the invention of US6263732, the patents focus on using the inside surface of the cup to provide the easy reading. It focuses on structure and nothing else. Perhaps other direction can shed some light on solving the same problem. For example, using the flexible wristband may serve another way to solve the same problem. This solution will be presented in one of the authors' thesis.

5. References

- Blevins, T. D. (1996), US Patent No. US5588747. Washington, DC: U.S. Patent and Trademark Office.
- Breit, O. and Kushner, R. G. (2016). US Patent No. Kushner,. Washington, DC: U.S. Patent and Trademark Office.
- Cameron, G. (2010). *TRIZICS*, CreateSpace.
- Espacenet patent search – Advanced search (2017, May 19). Retrieved from https://worldwide.espacenet.com/advancedSearch?locale=en_EP.
- Hoeting, M. G. and Hoeting, S. C. (2001). US Patent No. US6263732. Washington, DC: U.S. Patent and Trademark Office.
- Hughes, W. S. (2007). US Patent No. US7306120. Washington, DC: U.S. Patent and Trademark Office.
- Japan Patent Office, (2000). *Guide book for practical use of "patent map for each technology field"*, Asia-Pacific Industrial Property Center, JIII.
- Li, Z., Atherton, M., and Harrison, D. (2014). Identifying patent conflicts: TRIZ-led patent mapping, *World Patent Information*, 39, 11–23.
- Mann, D. (2002). *Hands-on systematic innovation*, CREAX Press.
- OXO – 3 Piece Angled Measuring Cup Set, (2017, May19).Retrieved from <https://www.oxo.com/products/preparing/measuring/3-piece-angled-measuring-cup-set>.
- Prince, F. C. (2013). US Patent No. US8517219. Washington, DC: U.S. Patent and Trademark Office.
- Rodriquez, O. J. (1980) *Spoon dropper*, US Patent No. US4192360. Washington, DC: U.S. Patent and Trademark Office.
- Szajnz, J. L. (1986). US Patent No. US4566509. Washington, DC: U.S. Patent and Trademark Office.
- Townsend, R. F. (1978). *Adjustable volume measuring cup*, US Patent No. US4073192. Washington, DC: U.S. Patent and Trademark Office.

AUTHOR BIOGRAPHIES



Jyhjeng Deng has been a Professor at DaYeh University in Taiwan since 1994. He received his Ph.D. degree in Industrial Engineering from Iowa State University. He is currently the Chair of the Industrial Engineering and Management Department at DaYeh University and a board member of the Society of Systematic Innovation. His areas of interests include systematic innovation, including TRIZ and patent analysis and circumvention, and computer graphics in product design.



Juin Yi Lee has been a graduate student at DaYeh University in Taiwan since 2015. He received his B.S. degree in Industrial Engineering from DaYeh University. His areas of interest include systematic innovation, including TRIZ and patent analysis and circumvention.

The Origin of the Reverse Umbrella

Jyhjeng Deng

Industrial Engineering and Management Department, DaYeh University, Taiwan

E-mail: jdeng@mail.dyu.edu.tw

(Received 5 October 2017; final version received 17 April 2018)

Abstract

There has been much online controversy and discussion among members of the Taiwan umbrella industry regarding who was the original inventor of the reverse umbrella, since Kazbrella, a British brand, was successfully launched. The purpose of the reverse umbrella is to keep the wet side of the umbrella away from the user on rainy days. Some people argue that the Taiwanese inventor Li Sheng Chun, the owner of Taiwanese patent I254619, was the originator of the reverse umbrella, although he did not put his patent into commercial practice. This paper traces the origin of the reverse umbrella and surveys patent databases in Taiwan, the USA and Europe. Based on the timeline of the application dates of patents, the trend of evolution in the Creax innovation suite is used to indicate the status of trends of dynamization of patents. It is discovered that the dynamic structure of the Kazbrella based on US8893736 is far more advanced than that of I254619. I254619 includes a sliding ring feature, which is connected with two honeycombs, sliding along the central spine of the umbrella. The honeycombs trigger the umbrella to fold inside out. Note that the umbrella is not foldable. The US8893736 umbrella, in contrast, is foldable with three moveable parts, including the upper crown, outermost section, and inner section, which are connected to the central spine and a pulley system to control the relative movement of the upper crown and inner section. Obviously the patent US8893736 has a higher status, approaching ideality in terms of the trend of object segmentation.

Keywords: Honeycomb, Kazbrella patent, Sliding support, Trend of dynamization

1. Introduction

Umbrellas are used on rainy days to partially cover the body and have been in use for thousands of years of human history (Umbrella History, 2017). As human society evolves, people have started to find out that more functions should be added to the umbrella. For example, when someone gets into a car outdoors during rainy weather, it is desirable to keep the umbrella dry in order to avoid spoiling the carpet or important papers inside the car. But how can a wet umbrella be kept dry? It seems like an impossible mission. From the perspective of the TRIZ physical contradiction, the umbrella must be wet because the weather is rainy; however, it must also be dry because we do not want it to spoil the things we like. This contradiction is solved by the principle of space separation (Altschuller, 1984; Bukhman, 2012). Due to the rainy weather, the outer surface of the outer canopy of the umbrella must be wet; with regard to the things we like, the inner surface of the

inner canopy of the umbrella must be kept dry. Principle number one, segmentation, of the 40 inventive principles is applied to solve the contradiction. The original canopy is segmented into two: an outer canopy and an inner canopy. In this way, raindrops are kept in the pocket formed by the outer canopy (which is collapsible) when the umbrella is closed by pulling the spine towards to the user. This procedure of closing the umbrella is just the reverse of the ordinary method. In this paper, we will discuss the origin of the reverse umbrella to settle the issue raised on the Internet regarding who was the originator of the reverse umbrella (Who Invented the Reverse Umbrella, 2017). Through the analysis of the patents for reverse umbrellas, the trend of dynamization is shown (Yoon and Kim, 2011).

The rest of the paper is organized as follows: Section 2 provides a literature review on the reverse umbrella and trend of evolution. Section 3 gives a detailed description of the technology used in reverse umbrellas. Section 4 concludes the paper.

2. Literature review

There is hardly any literature concerning the reverse umbrella in research literature databases in either English or Chinese. However, some patents exist in the patent database. There are three kinds of reverse umbrellas shown on the Internet, and their brand names and inventors can be obtained; they are 李盛群 (Li Sheng-Chiun) (Who Invent Reverse Umbrella, 2017), 神美伞 (Shen-Mei umbrella, 2017), and Jenan Kazim (Reverse Folding Umbrella, 2017). The corresponding patents are TWI254619 (Li, 2006), TWM522603 (Wu, 2016), GB2346556 (Kazim, 2001), US8893736 (Kazim, 2014), and US20150265013 (Kazim, 2015). Using the backward and forward citations of those patents in the European patent database (Espacenet Patent Search, 2017), it is easy to derive the cited and citing documents, as shown in Tables 1–3. Note that there are no citations for TWI254619 and TWM522603, no forward citations for US8893736, and no backward citations for US20150265013. Each patent states the filing date and whether the published patent (kind code A) is followed by an approved patent (kind code B); the approved patent is stated beside the published patent. Tables 1–3 show the technology history of the reverse umbrella. It is clear that the earliest attempt to solve the problem was made in 1968 with the patent GB1233564.

The patents show that nations like the UK, Italy, Japan, the USA, Taiwan, and China are involved in tackling the reverse umbrella problem. Due to the limited paper length, those patents will not be further pursued.

After discussing the patent search for the reverse umbrella, the paper turns to the trend of evolution. One of the main tools in the TRIZ is the ideality concept, where ideality = conceived benefit/(cost + harm) (Mann, 2002). The general TRIZ trend on ideality is that most systems increase their ideality by changing during each phase of the trend, from low ideality to high ideality. There are 35 trends in the trend of evolution (Mann, 2002). For example, in the trend of dynamization, the phases of the technological system could be immobile, single joint, multiple joints, completely flexible, liquid/gas, and field. In the trend of object segmentation, the phases of the technological system could be monolithic solid, segmented solid, highly segmented solid, solid granules, solid powder, monolithic liquid, segmented liquid, aerosol, gas, plasma, field, and sparse field (Creax Innovation Suite, 2001). By identifying the current status of the technological system, a possible jump forward can be sought.

Lastly, the product architecture (Pahl and Beitz, 1999; Fiorineschia, Frillicia, Rissonea, and Cascinib, 2015) can be useful in analyzing the product (in our case, the reverse umbrella) and grouping its components into different modules. The product architecture of a product is composed of two layers, one for components and the other for their functions, and the components and functions are linked together so that module can be easily identified through functions. A sample product architecture is shown in Figure 1.

Table 1 Citation of GB2346556

| Kazbrella patent | Backward citation (cited documents) | Forward citation (citing documents) |
|-----------------------------------|---|---|
| GB2346556 filing date: 2000-02-14 | GB1233564 (GB2019210) filing date: 1968-02-14 | US20150265013 (GB2507649) filing date: 2013-09-27 |
| | GB1581103 filing date: 1978-05-12 | US2013092206 (US8733378) filing date: 2012-03-22 |
| | GB2239173 filing date: 1989-12-19 | US2012240969 (US8893736) filing date: 2010-09-20 |
| | GB2320893 filing date: 1997-01-06 | US2010031984 (US8011379) filing |

| | | |
|--|-----------------------------------|--|
| | | date: 2008-02-01 |
| | GB2329123 filing date: 1997-09-10 | US2006016465 (US7523759) filing date: 2005-07-26 |
| | EP0596180 filing date: 1992-11-02 | |
| | US3935874 filing date: 1975-12-18 | |
| | US4456023 filing date: 1981-07-25 | |
| | WO8703460 filing date: 1985-12-12 | |
| | WO9748303 filing date: 1996-06-17 | |

Table 2 Citation of US8893736

| Kazbrella patent | Backward citation (cited documents) | Forward citation (citing documents) |
|-----------------------------------|--|-------------------------------------|
| US8893736 filing date: 2010-09-20 | US3435836 filing date: 1967-06-20 | |
| | US3534752 filing date: 1969-02-03 | |
| | US3709238 filing date: 1971-03-26 | |
| | US4007753 filing date: 1976-01-22 | |
| | US2004211451 filing date: 2004-04-27 | |
| | US2007089768 (US8733378) filing date: 2005-10-22 | |
| | US2007169801 (US7484518) filing date: 2007-01-22 | |
| | JPH0467803 (JPH088882) filing date: 1990-07-06 | |
| | JPH0856725 filing date: 1994-08-19 | |
| | JP2007181657 (JP4108720) filing date: 2005-12-09 | |
| | JP2013141462 (JP5912535) filing date: 2012-01-06 | |

Table 3 Citation of US20150265013

| Kazbrella patent | Backward citation (cited documents) | Forward citation (citing documents) |
|---|-------------------------------------|-------------------------------------|
| US20150265013 (GB2507649) filing date: 2013-09-27 | | US9629426 filing date: 2016-05-04 |
| | | US9538819 filing date: 2016-04-19 |

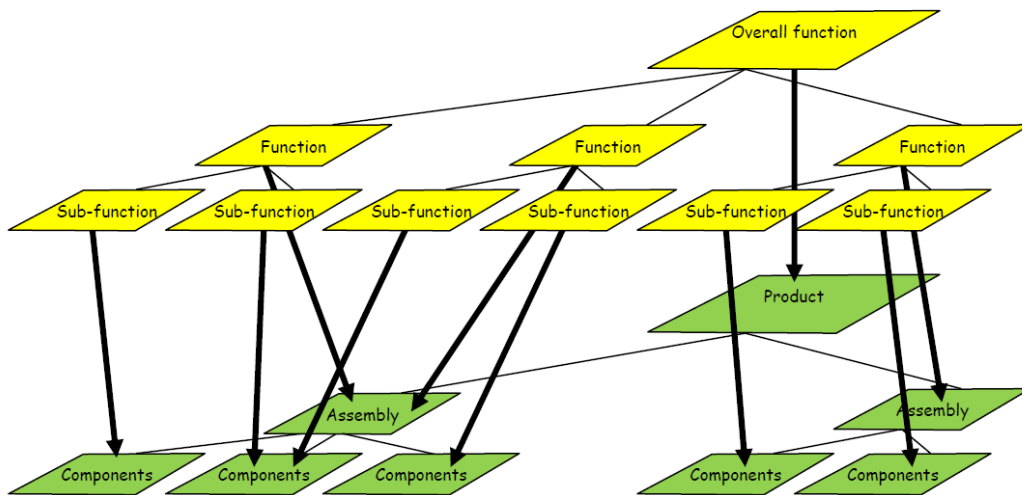
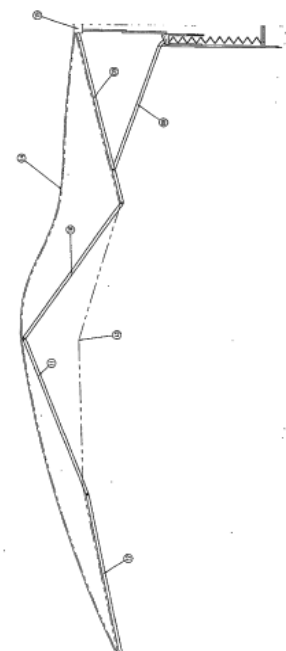

Figure 1. Product architecture in terms of functional elements and physical elements.

3. Technology of Reverse Umbrella

Due to the limit on the paper length, descriptions of the five patents listed in the previous section will be given in detail and are shown in Table 4.

Table 4 Technological descriptions of the patents.

| Patent | filing date | Technological description | Figures | Status in the trend of dynamization |
|-----------|-------------|---|--|-------------------------------------|
| GB2346556 | 2000-02-14 | The compact umbrella has one canopy fabric and uses several sets of four studs, 9–12, a spoke, 08, and air tubes, 13 and 14, to make the canopy fold in such a way that its dry region is on the outside. The air tube is activated by a plunger to right itself when blown inside out. |  | The stud has multiple joints. |

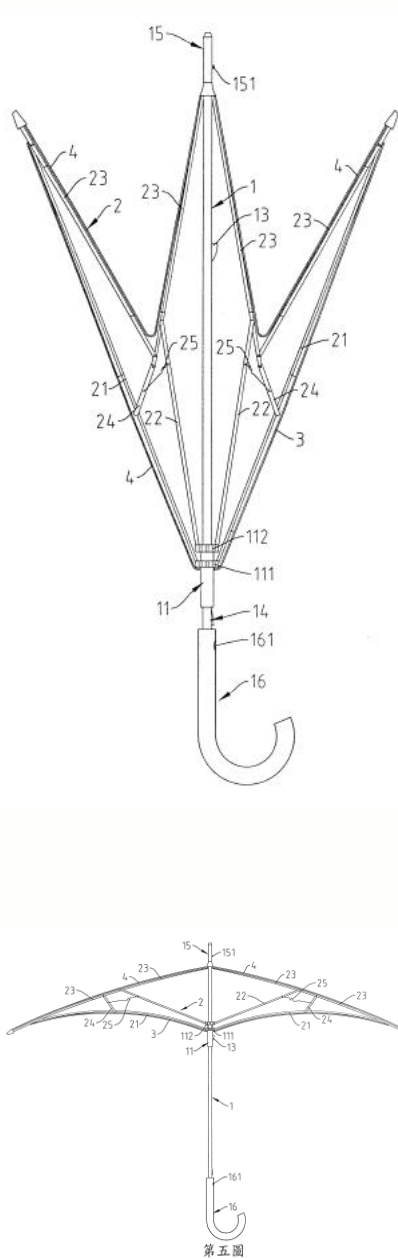
| | | | | |
|---------------|------------|--|--|---|
| TWI254 619 | 2004-09-01 | There are two canopies, the inner canopy, 3, and the outer one, 4, where the outer canopy, 4, is foldable so that the outside of the outer canopy, 4, can form a cavity to collect raindrops. The extension of the two canopies is operated by a sliding ring, 11, with two honeycomb structures attached therein. |  <p style="text-align: center;">第五圖</p> | In the structure with the sliding rim, 11, the sliding rim is immobile. |
|---------------|------------|--|--|---|

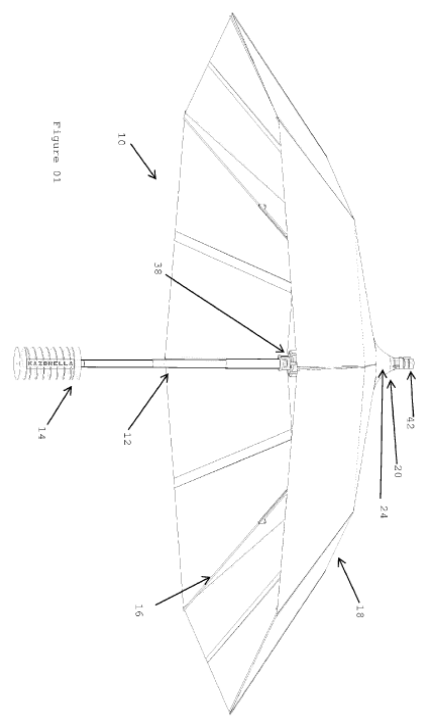
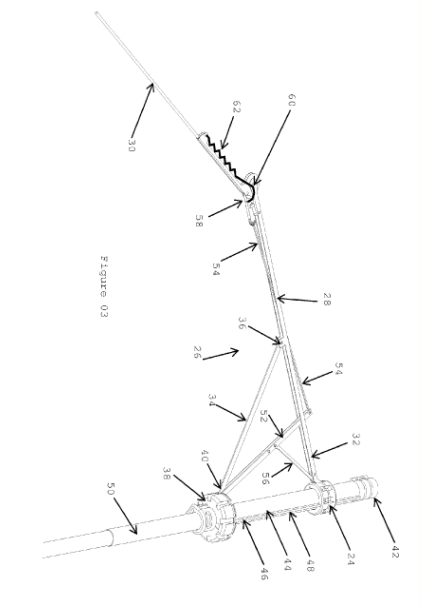
| | | | | |
|---------------|------------|---|---|--|
| US8893 736 | 2010-09-20 | <p>The compact umbrella has a main canopy, 18, and a collapsible canopy framework, 16, including a pulley system housing, 42, upper crown, 24, and lower crown, 38. The pulley systems trigger the relative movement of the upper crown and lower crown. An inner strut, 28, is connected to the upper crown, whereas the outer strut, 30, is remotely connected to the lower crown with an actuation system, 52.</p> |   | <p>There are two crowns, an upper crown and a lower crown, sliding on the central spine. This makes the collapsible canopy framework run smoothly.</p> |
|---------------|------------|---|---|--|

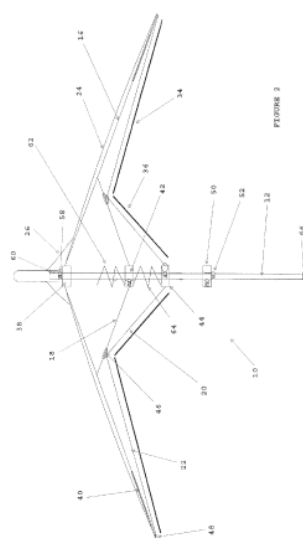
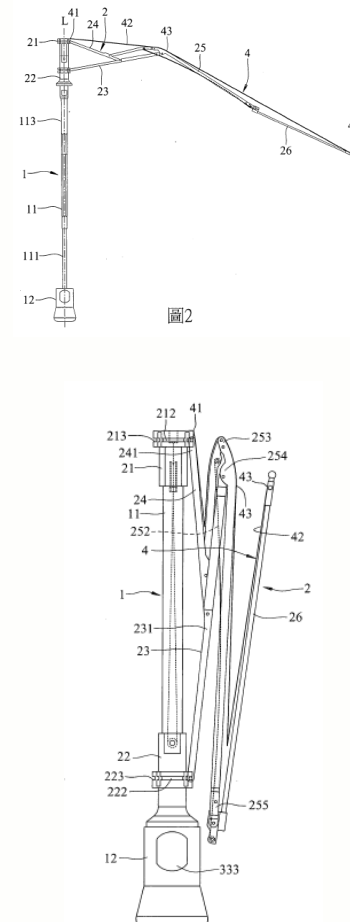
| | | | | |
|-------------------|------------|--|--|--|
| US2015 0265013 | 2013-09-27 | There is one main canopy, 24, and optional internal canopies, 34 and 36. There are also four sliding supports, a first, 38, a second, 42, a third, 44, and a fourth, 50, which are connected to the central spine, 12. The fourth sliding support, 50, contains a pulley system which controls the movement of the first and second sliding supports. In addition, a sliding strut, 40, and a sliding pivot, 46, are provided to allow the umbrella to open and close more smoothly. |  | There are four sliding supports on the central spine, where the fourth sliding support contains the pulley system. |
| TWM52 2603 | 2015-11-03 | This compact umbrella uses only one canopy. However, the outside of the canopy can be folded three times such that it forms a cavity to retain raindrops. Beside the main rib, 23, there are three supporting ribs, a first, 24, a second, 25, and a third, 26, respectively. |  | The rib structure has multiple joints. |

Looking at the Table 4, several key findings can be observed. First, only patent TWI254619 tackles the raindrop problem using a regular size umbrella, while the other four patents, GB2346556, US8893736, US20150265013, and TWM522603, are for compact umbrellas. Second, the patent TWI254619 does not provide rigid proof that its linkage of the struts can work properly in opening and closing the umbrella. Besides, there is no prototype to demonstrate its functionality. Third, although there are three patents for compact umbrellas from Kazbrella, GB2346556, US20150265013, and US8893736, there is no commercial product yet. Kazbrella has only presented a reverse umbrella for a regular size umbrella, not a foldable umbrella. This makes us curious about why there is no commercial foldable reverse umbrella from Kazbrella, even though it has three patents on it. Perhaps the technology presented in the patent is difficult or expensive to make. On the contrary, patent TWM522603 has been put on market as a commercial product, the compact reverse umbrella. Investigating the patent GB2346556 shows that using an air tube to self-right the umbrella seems implausible. Fourth, two canopies are used in the regular size umbrella, whereas only one canopy can be used in the compact umbrella. Fifth, there are two types of evolutionary trend in the case of the umbrella: one is the trend of dynamization and the other is the trend of object segmentation. In the dynamization trend, the stud connected to the central spine evolves from immobile (TWI254619) to single joint to multiple joints (US20150265013). In the trend of object segmentation, the sliding support evolves from monolithic solid (TWM522603) to segmented solid (US8893736).

To further assist the understanding of patents TWI254619 and US8893736, their function attribute models (Mann, 2002) from the first independent claims are stated. Meanwhile, their working principles and product architectures will be stated in sequence. The function attribute model is augmented from the function model with attributes of parts specified on the boundaries of the parts. The function attribute model of the first independent claim of TWI254619 is shown in Figure 2. The attribute of the object is depicted in the

corner of the box of the object. For example, two attributes, namely the upper and preset positions, are attached to the main support, 2, in the top left of Figure 2. The first independent claim is stated in the format of a function attribute model as follows, and it can be read together with the umbrella structure in Figures 3 and 4.

A main pole, 1, is set up with a sliding ring, 11, where the sliding ring, 11, is set up with the first honeycomb, 111, and second honeycomb, 112. The main pole, 1, is set up with the shaft, 14, and end pole, 15, at either end. Thereby, both the shaft, 14, and the end pole, 15, are set up with buckles, 141, respectively, to set up with a handle, 16, for practical situations. The umbrella framework is composed of an inner brace, 21, and an inner framework, 22, where the inner brace, 21, is set up with the first honeycomb, 111, and the inner framework, 22, is set up with the second honeycomb, 112, in a radial state. A folding brace, 23, is set up at the bottom end of the end pole, 15. A moving brace, 24, pivots on the middle part of the folding brace, 23. An inner canopy, 3, is combined with the inner brace, 21. An outer canopy is combined with the folding brace, 23. Due to the interchangeable position of the handle, 16, between the shaft, 14, and the end pole, 15, through the buckles, 141, the handle, 16, can be placed at the shaft, 14, during normal weather whereas the handle, 16, can be placed at the end pole, 15, to collect raindrops during rainy days.

In Figure 3, the umbrella is in normal mode, where it is expanded to protect the user. In this case, the handle, 16, is placed at the shaft, 14. On the other hand, in raindrop-collection mode, the handle, 16, is switched to the end pole, 15, so that the outer canopy can hold the raindrops as shown in Figure 4. In practice, it is not necessary to install two buckles, 141, at both the shaft, 14, and the end pole, 15. Only one buckle, 141, is needed at the shaft, 14. When the user wants to collect the raindrops, he or she just pulls the sliding ring, 11, towards the handle, 16, so that the outer canopy, 4, can collect them. In this way, the operation of switching the handle, 16, from the shaft, 14, to the end pole, 15, can be avoided. Indeed, Kazbrella uses this method to collect the raindrops.

Figure 5 shows the function attribute model based on the first independent claim of US8893736. It can be read together with the umbrella structure shown in Figures 6–8. Figure 6 shows the open position of the umbrella. Figure 7 shows that the outer strut, 30, is pivoted clockwise at the hinge, 60, when the upper crown, 24, is pulled close to the lower crown, 38, to close the umbrella. In this way, the outer strut, 30, is bent inward and is surrounded by the inner strut, 28, so that only the dry side of the canopy is shown outside, as shown in Figure 6. The independent claim 1 is stated below.

This is a foldaway umbrella that is moveable between an open configuration and a closed configuration. Said umbrella comprises: a) a central spine, 12; b) an upper crown, 24, that is moveable with respect to the central spine, 12; c) a lower crown, 38, that is fixed with respect to the central spine, 12; d) a canopy framework, 16, connected to the upper crown, 24, and the lower crown, 38; and e) a main canopy, 18, covering the canopy framework, 16; this main canopy, 18, has its inside face closest to the canopy framework and its outside face furthest from the canopy framework, so that movement of the upper crown, 24, from a position

far from the lower crown, 38, to a position close to the lower crown causes the canopy framework and thus the main canopy to move from the open configuration to the closed configuration, wherein the main canopy, 18, is folded inside out such that only the inside face of the main canopy is exposed and movement of the upper crown from a position close to the lower crown to a position far from the lower crown causes the canopy framework and thus the main canopy to move from the closed configuration, where the main canopy is folded inside out such that only the inside face of the main canopy is exposed, to the open configuration, where the central spine, 12, comprises an outermost section, 44, and an inner section, 50; the inner section, 50, is movable inside the outermost section, 44; the lower crown, 38, is fixed to the outermost section of the central spine, and the upper crown, 24, is moveable with respect to the outermost section, 44, of the central spine 12, and movement of the inner section, 50, of the central spine, 12, out of the outermost section, 44, of the central spine results in the movement of the upper crown from a position close to the lower crown, 38, to a position far from the lower crown, 38, and the inner section, 50, of the central spine, 12, is connected to the upper crown, 24, by a string and pulley system, 42.

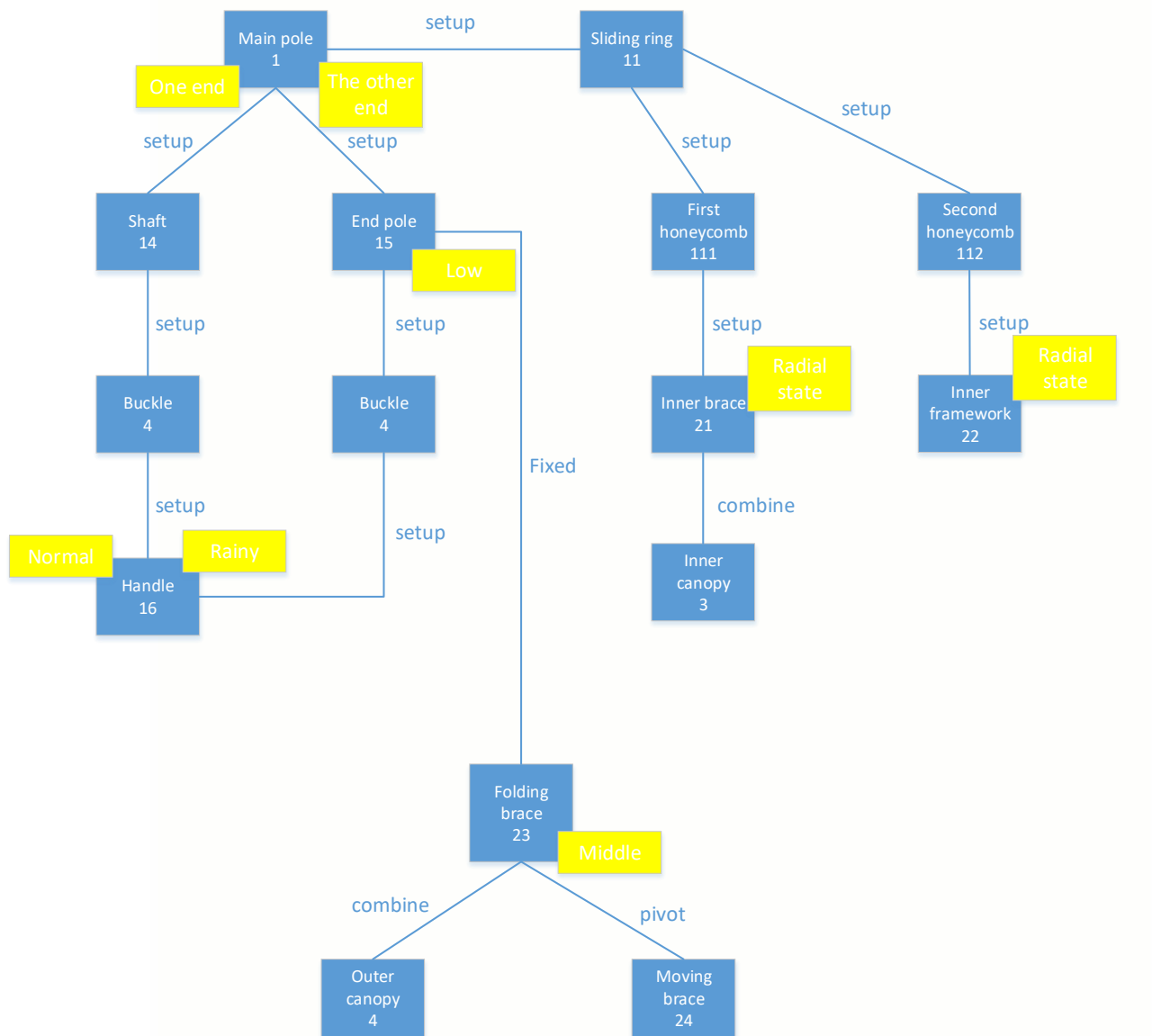

Fig. 2 Function attribute model of the first independent claim of TWI254619

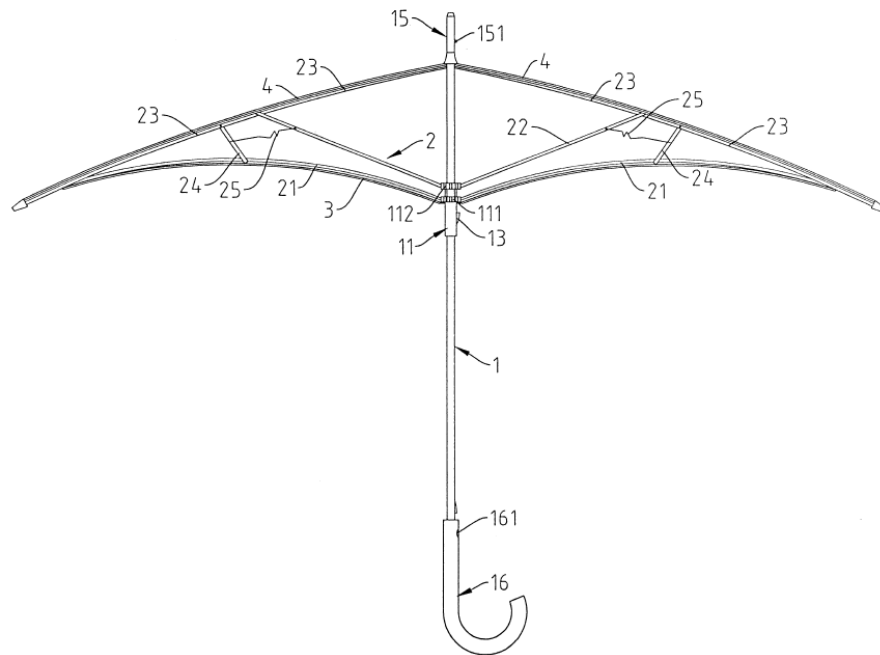

Fig. 3 An umbrella in normal usage

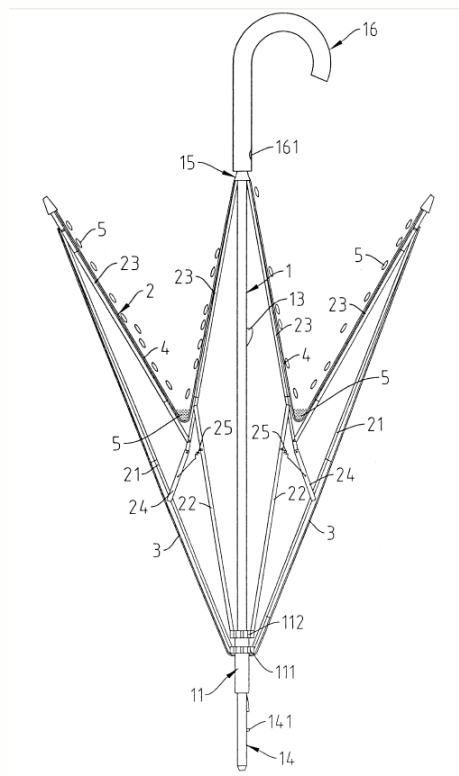

Fig.4 An umbrella in raindrop-collection mode

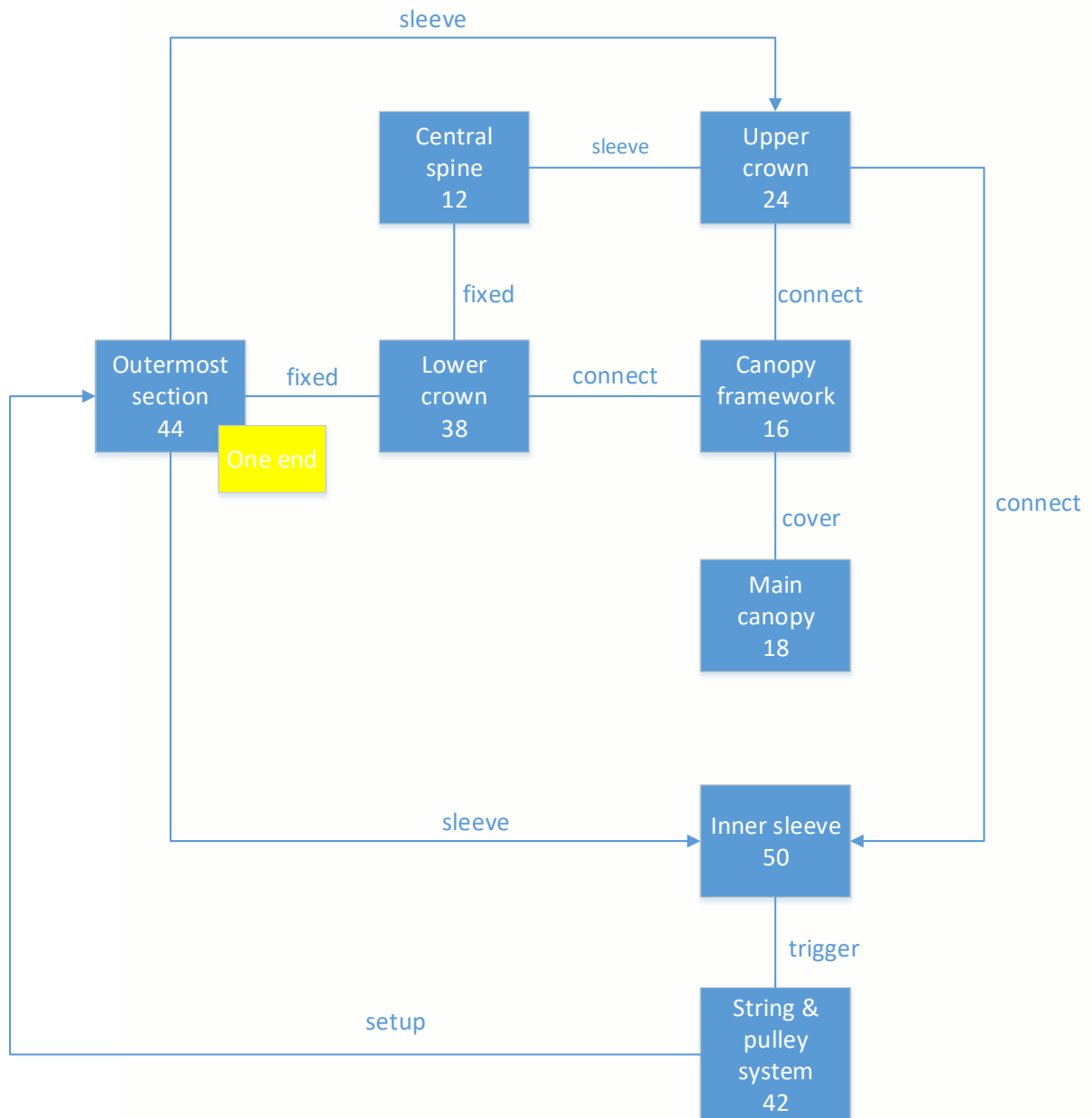

Fig. 5 Function attribute model of the first independent claim of US8893736

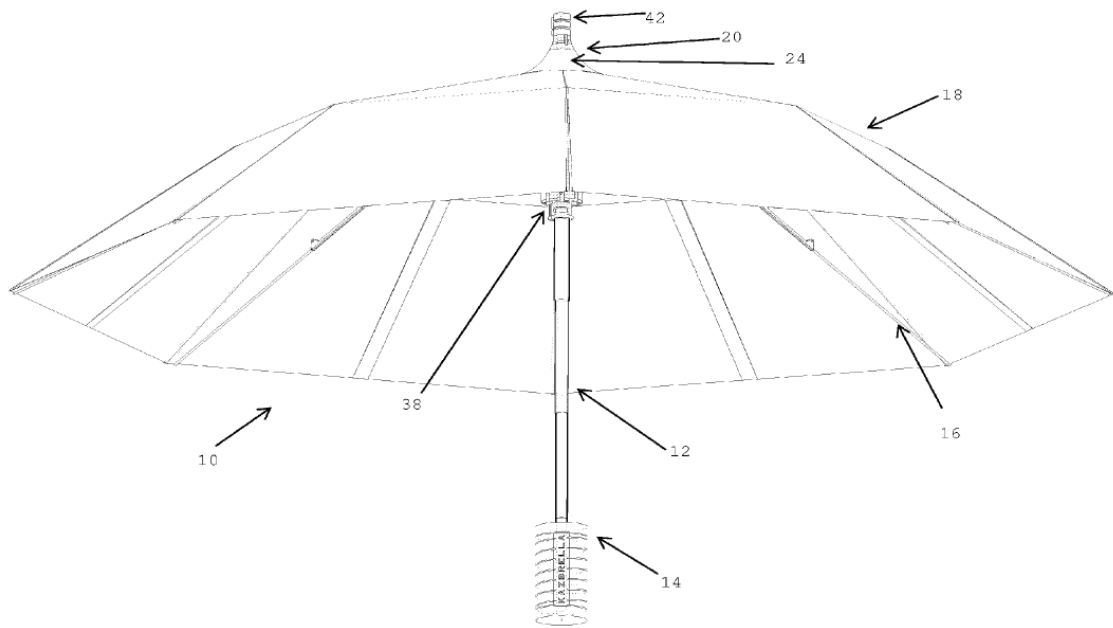

Fig. 6 Umbrella in open position

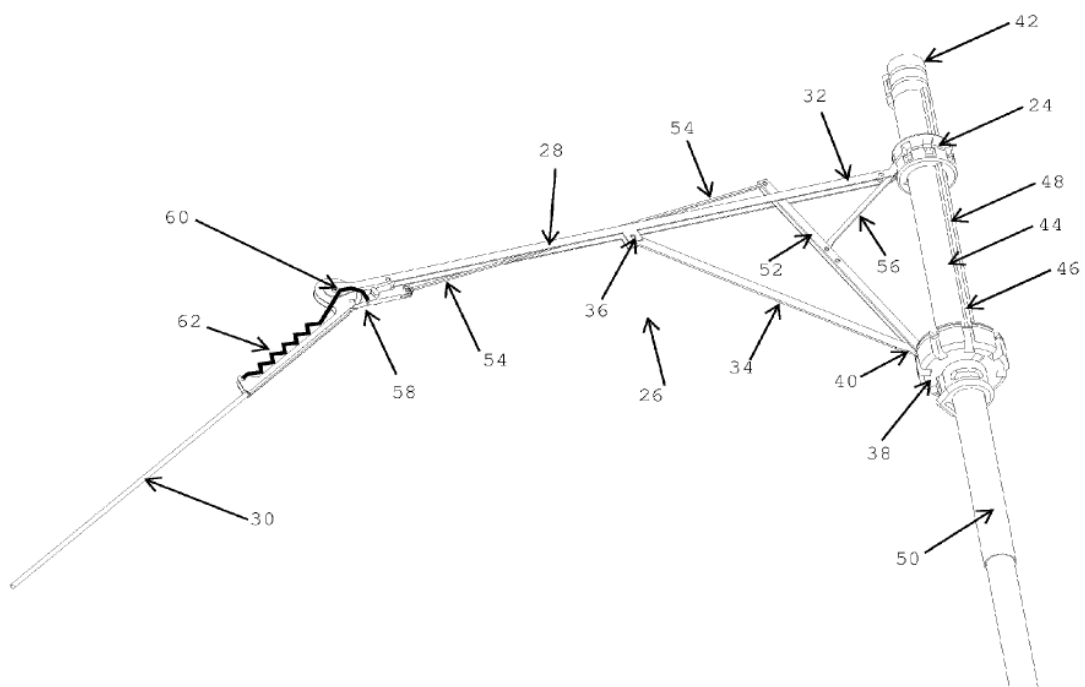

Fig. 7 Umbrella framework

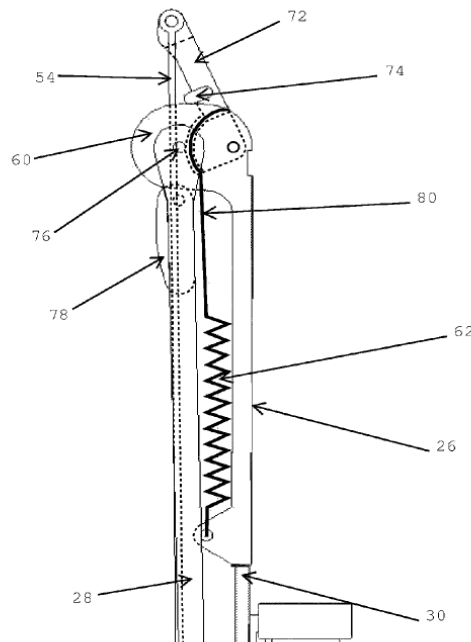

Fig. 8 Umbrella in closed position

The working principle of TWI254619 is stated as follows. A folding brace, 23, is pulled by the inner brace, 21, and inner framework, 22, which are radially spread out from the first and second honeycombs, 111 and 112, when the sliding ring, 11, slides down the handle, 16. In this way, a V-shape is formed in the outer canopy, 4, so that pockets are formed to collect the raindrops.

Pahl and Beitz (1999) define the product architecture as a scheme showing the relationship between the function structure of a product and its physical configuration; a graphical representation of this definition is shown in Figure 1. As seen in Figure 1, there are two layers in the graph: one concerns the components and

the other concerns their corresponding functions. It is possible to associate two functions with a sub-assembly. When the components become larger, the graph will become messy. In cases where each component and sub-assembly has only one corresponding function, then it may be better to separate the two layers into two separate graphs. Thus for the sake of clarity of presentation, we will separate the components and functions into two different graphs. They are presented in Figures 9 and 10 for the product architecture of TWI254619. It can be clearly seen in Figures 9 and 10 that the shaft and the end pole have identical functions. Thus one of them, namely the end pole, and its associated buckle can be trimmed.

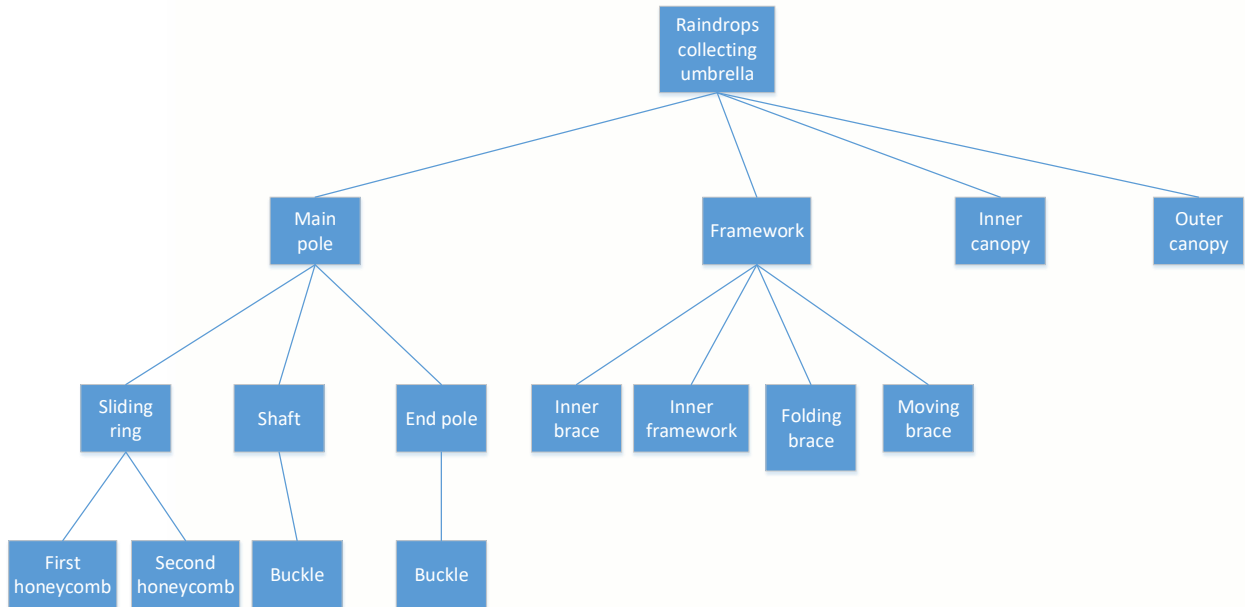

Fig. 9 Product architecture of TWI254619 – components

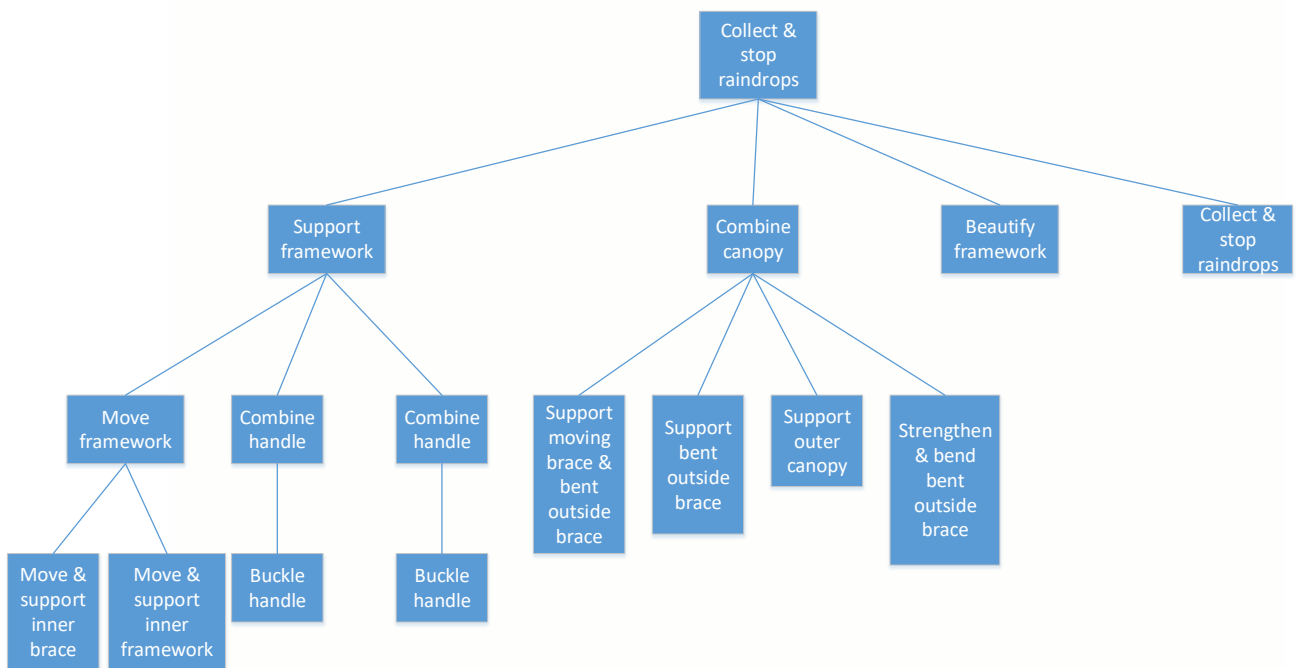

Fig 10 Product architecture of TWI254619 – functions

The working principle of US8893736 is that the upper crown, 24, is pulled close to the lower crown, 38, so that the push and pull rod, 54, will be drawn near to the central spine, 12. Then, the outer strut, 30, rotates around the hinge, 60, clockwise so that the inner strut, 28, surrounds the outer strut, 30. In this way, the dry

side of the canopy will always be on the outside, so that raindrops will be kept within the foldaway umbrella. The component and function graphs of the product architecture of US8893736 are shown in Figures 11 and 12, respectively.

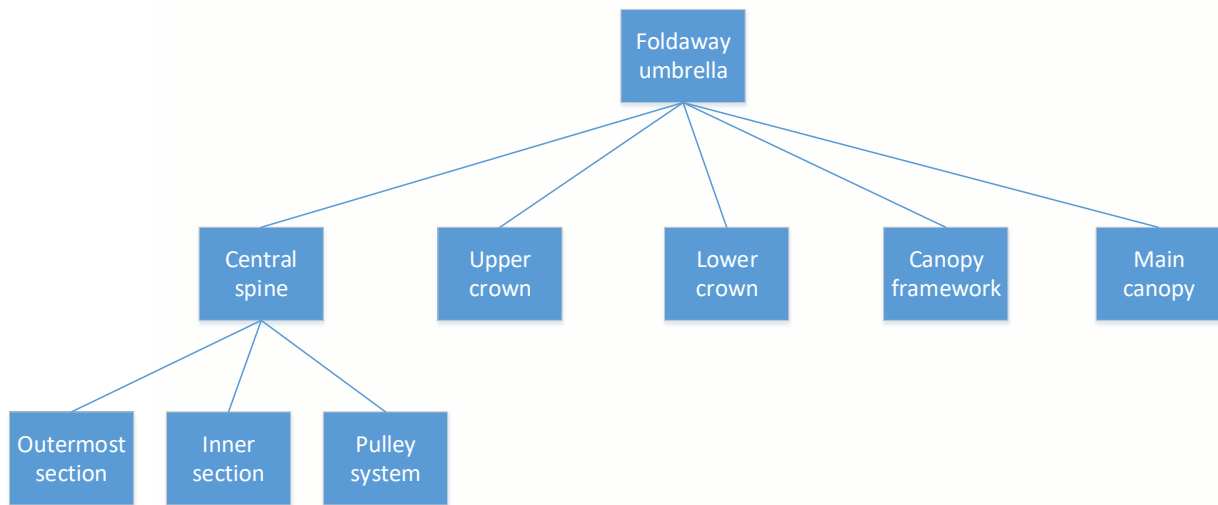

Fig. 11 Product architecture of US8893736 – components

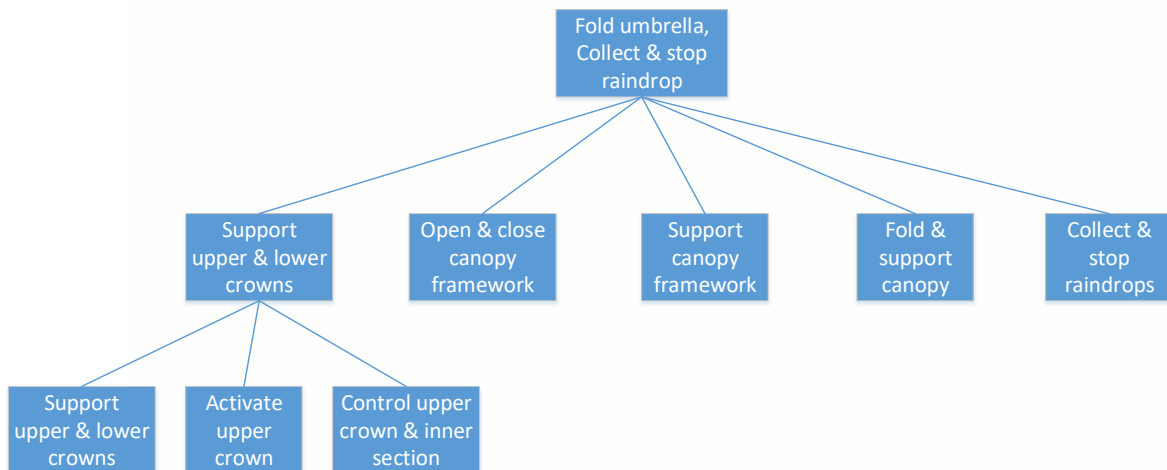

Figure 12. Product architecture of US8893736 – functions

A comparison of the function attribute models of the first independent claims between TWI254619 and US8893736 shows that although the structure of TWI254619 looks clumsier than that of US8893736, it is indeed simpler. This is because the canopy framework, 16, of US8893736 contains many components that are shown in the model. In terms of technological complexity, that of TWI254619 is simpler; however, in terms of operating efficiency, that of US8893736 is better. Of course, these two patents belong to two different categories, namely the conventional umbrella and the compact umbrella.

Comparing the working principles of these two patents, that of TWI254619 uses inventive principle (IP) 1, segmentation, to convert one canopy into two canopies, namely the inner canopy and the outer canopy. However, that of US8893736 uses three inventive principles: 12, equipotentiality, 15, dynamization, and 17, another dimension. The use of the pulley is related to IP 12, because the user does not need to stretch out his or her hand to reach the upper crown. The use of the canopy framework is related to IP 15 because the canopy framework can change its structure between open and closed positions. The folding of the outer strut in the canopy framework applies IP 17 so that the dry side can be erected in the closed position.

Comparing the product architectures of these two patents, their main functions are slightly different. The structure of TWI254619 collects and stops raindrops, while that of US8893736 has, beside the previous two functions, an additional function of being a folding umbrella. In order to perform folding, the canopy structure applies IP 15 to change its structure between the open and closed positions.

In sum, Table 5 lists the similarities and differences between TWI254619 and US8893736. There are two points in common between these two patents. One is that they both fold canopies to collect rain drops. The other is that they use a spring and brace to fold the canopy. There are four differences between them. First, one uses a double canopy and the other uses only a single canopy. Second, one is a conventional umbrella

and the other is compact. Third, one uses an inner canopy to cover the folding mechanism and the other uses a sleeve to cover it. Fourth, one has a pulley and the other has not.

By now, we are able to answer our original question: who was the original inventor of the reverse umbrella? It seems that Mr Jenan Kazim (GB2346556, filing date 2000-02-14), was the first to tackle the foldable reverse umbrella problem. Note that GB2346556 uses only one canopy. His first patent, GB2346556, was proposed much earlier than that of TWI254619 (filing date 2004-09-01). However, the concept of the double canopy used in the conventional reverse umbrella was first proposed by Mr Li Sheng-Chiun, the inventor of patent TWI254619.

In patent TWI254619, only one sliding support is connected to the central spine, whereas in patent US8893736, three moveable parts, namely the upper crown, outermost section, and inner section, are connected to the central spine and a pulley system to control the relative movement of the upper crown and inner section. Obviously the patent US8893736 has a higher status, approaching ideality in terms of the trend of object segmentation.

Table 5 Similarities and differences between TWI254619 and US8893736.

| | TWI254619 | US8893736 |
|------------|---|--|
| Similarity | 1. Fold the canopy to collect rain drops 2. Use spring and brace to assist folding canopy | |
| Difference | 1a Double canopy 2a Conventional 3a Use inner canopy to cover the folding mechanism. 4a Without pulley | 1b Single canopy 2b Compact 3b Use sleeve to cover the folding mechanism 4b With pulley |

4. Conclusion

A study of the originality on the reverse umbrella was conducted to solve the dispute on the Internet regarding who was the original inventor of the reverse umbrella. Five patents were investigated in detail with regard to their technological aspects: GB2346556, TWI254619, US8893736, US20150265013, and much earlier than TWI254619 (filing date 2004-09-01), but has never been put on the market as a commercial product. However, the concept of the double canopy used in the reverse umbrella was first proposed by Mr Li Sheng-Chiun, the inventor of patent TWI254619. Mr Li and Mr Kazim used different mechanisms to solve the reverse umbrella problem, which can be best demonstrated by patents TWI254619 and US8893736. In patent TWI254619, only one sliding support is connected to the central spine, whereas in patent US8893736, three moveable parts, namely the upper crown, outermost section, and inner section, are connected to the central spine and a pulley system to control the relative movement of the upper crown and inner section. Obviously the patent US8893736 has a higher status, approaching ideality in terms of the trend of object segmentation.

Further comparison of the function attribute models, working principles, and product architectures between the first independent claims of TWI254619 and US8893736 reveals several technology insights. The comparison of the function attribute models of the first independent claims between TWI254619 and US8893736 shows that although the structure of TWI254619 looks clumsier than that of US8893736, it is indeed simpler. This is because the canopy framework, 16, of US8893736 contains many components which are shown in the model. In terms of technologi-

TWM522603. Only patent TWI254619 tackles the raindrop problem with a regular size umbrella, whereas the other four patents, GB2346556, US8893736, US20150265013, and TWM522603, are compact umbrellas. As for the foldable reverse umbrella, it seems that Mr Jenan Kazim (GB2346556, filing date 2000-02-14) was the first to tackle the reverse umbrella problem. His first patent, GB2346556, was proposed

cal complexity, that of TWI254619 is simpler, but in terms of operational efficiency, that of US8893736 is better. Of course, these two patents belong to two different categories: the conventional umbrella and the compact umbrella.

Comparing the working principles of these two patents, those of TWI254619 use IP 1, segmentation, to convert one canopy into two canopies, namely the inner and outer canopies. However, the working principles of US8893736 use three inventive principles: 12, equipotentiality, 15, dynamization, and 17, another dimension. The use of the pulley is related to IP 12 because the user does not need to stretch out his or her hand to reach the upper crown. The use of the canopy framework is related to IP 15, because the canopy framework can change its structure between open and closed positions. The folding of the outer strut in the canopy framework applies IP 17 so that the dry side can be erected in the closed position.

Comparing the product architectures of these two patents, their main functions are slightly different. The functions of TWI254619 are to collect and stop raindrops, whereas US8893736 has, beside the previous two functions, the additional function of being a folding umbrella. In order to perform the folding, the canopy structure applies IP 15 to change its structure between the open and closed positions.

5. References

- Altschuller, G., Creativity as an Exact Science: the Theory of the Solution of Inventive Problems, 1984 (Gordon and Breach).
- Bukhman, I., TRIZ Technology for Innovation, 2012 (Cubic Creativity Company).
- Creax Innovation Suite, Computer software, 2001.
- Espacenet Patent Search – Advanced Search (2017, May 19). Retrieved from https://worldwide.espacenet.com/advancedSearch?locale=en_EP.
- Fiorineschia, L., Frillicia, F. S., Rissonea, P. and Cascinib, G., Product Architecture definition: evaluating the potentiality of TRIZ tools, *Procedia Engineering*, 2015, 131, 359–371.
- Kazim, J., Improved foldaway umbrella, British patent, GB2346556, 2001.
- Kazim, J., Umbrella folding upward and inside out, US patent, US8936736, 2014.
- Kazim, J., Umbrella, US patent, US20150265013, 2015.
- Li, S. C., Umbrella with rainwater collector, Taiwanese patent, TW I254619, 2006.
- Mann, D., Hands-on systematic innovation, 2002 (Creax Press).
- Pahl, G. and Beitz, W., Engineering Design. 2nd ed., 1999 (Springer-Verlag, London)
- Reverse folding umbrella (2017, May 19). Retrieved from <https://kazbrella.com/>.
- Shen-Mei umbrella (2017, May 19). Retrieved from http://www.jojogo168.com/3g_news_content.php?id=385.
- Umbrella history (2017, May 19). Retrieved from <http://www.umbrellahistory.net/>.
- Who invented the reverse umbrella (in Chinese) (2017, May 19). Retrieved from <http://crowdwatch.tw/reports/126>.
- Wu, C. X., Multi-fold automatic reverse folding umbrella, Taiwanese patent, TWM522603, 2016.
- Yoon, J. and Kim, K., An automated method for identifying TRIZ evolution trends from patents, *Expert Systems with Applications*, 2011, 38, 15540–15548.

AUTHOR BIOGRAPHIES



Jyhjeng Deng has been a Professor at DaYeh University in Taiwan since 1994. He received his Ph.D. degree in Industrial Engineering from Iowa State University. He is currently the Chair of the Industrial Engineering and Management Department at DaYeh University and a board member of the Society of Systematic Innovation. His areas of interests include systematic innovation, including TRIZ and patent analysis and circumvention, and computer graphics in product design

Innovative Solutions for Traditional Saudi Arabian Costumes Using TRIZ Principles

Wafa H. Shafee and Laila A. Fedá

Department of Fashion & Textile Design, college of Art & Design, Princess Norah Bint Abdulrahman University,

E-mail: washafee@pnu.edu.sa; lafeda@pnu.edu.sa

(Received 20 October 2017; final version received 30 September 2018)

Abstract

This research is about finding solutions to obstacles that limit using traditional women's costume in Saudi Arabia by adopting TRIZ principles, to design an innovative fashion collection which is commensurate women needs in the current era while reflecting a traditional legacy. Research tools consist of a questionnaire about contemporary women's clothes, a business matrix of contradictions, and principles of TRIZ theory. The research resulted in the ability to design a contemporary fashion collection focusing on the positive factors in traditional clothing by applying TRIZ principles 10/Preliminary Action, 15/Dynamization, and 35/ Parameter Changes, which helped in reducing production cost and time. In addition, solving the obstacles to the spread of traditional clothes, which include convenience and communication flow.

Keywords: TRIZ theory, Systematic innovation, Traditional clothes, Contemporary clothes.

1. Introduction

Human societies are essentially based on the customs and traditions that constitute their cultural heritage, of which habits are an important part. But, humans can adjust their habits as their environment evolves and develops. Some of fashion's heritage elements, for example, are now considered useless because they conflict with modern circumstances; therefore, adjustments became necessary to suit modern condition.

One effect of globalization has been a growing desire for women to follow international fashions, along with a constant quest for renewal. However, one of Saudi Arabia's Vision 2030 goals is to preserve Saudi Arabia's national identity through the preservation of the country's cultural heritage in traditional costumes. The theory of inventive problem solving, or Teoria resheniy izobretatelskikh'zadatch (TRIZ - the English acronym is TIPS) (Savransky, 2000) can be applied to help the country to meet this vision.

TRIZ is a methodology that can be used to develop creative thinking to find inventive solutions to

problem (Abu Jado, 2007). The Soviet scientist Genrich Altshuller and his colleagues developed the theory between 1946 and 1959. Altshuller discovered that behind all innovations and inventions, 40 design principles can be applied to solve any problem. The theory was published in 1969, and in 1989 he founded the Russian TRIZ Association (Altshuller, Clarke, Shulyak, & Lerner, 2005) and (Jiang, 2010). The patent of the examined documents reached more than three million (Barry, Domb, & Slocum, 2017).

TRIZ theory appeared in the Arab world in 2003 (Abu2 Jado & Nofal, 2017). Despite its discovery and original use in the fields of engineering and technology, TRIZ theory can also be applied in other disciplines, such as management, social relations, literature, and the arts. In Saudi Arabia, Alrafei (2008) tested some of the TRIZ principles of innovative solutions to problems on first year secondary students from the Asir region. Alrafei clearly concluded that the use of this theory leads to the development of problem-solving skills.

In this research TRIZ theory was chosen because it uses logic in solving problems within a limited tech-

nical scientific approach, and that is to choose a suitable solution within 40 principles which stops the occurrence or frequency of the problem, especially if it was resulted due to a component of issues as production, esthetical, or social without aligning to a specific solution.

The underlying problem in preserving long-established Saudi Arabian fashion is the lack of traditional-style designs in contemporary fashion ranges, despite a distinguished heritage of distinctive construction lines and colors, and decoration and ornamentation. Therefore, it is important to specify the underlying reasons causing this problem from a Saudi woman's perspective, in addition to analyzing them according to TRIZ principles. This should allow us to reach creative solutions that rely on logic to ensure the continuation of Saudi traditional fashion cultural heritage

2. Literature Review

Forming an idea or an innovative visualization for a new product is based upon inferred variables, including the consideration of a product, experience. Innovation and creativity are the openings for renewal in any field, and any type of work could be considered an innovation if it is intentional, out of routine, and offers a new generalized service (Tayeb, 2016).

Consumer's creative behavior depends on fashion trends that they make by coordinating existing fashion and determining what fits within that fashion style, and then buying new complementary products. Therefore, the unique and innovative fashion look styled by consumers can be a source of inspiration for manufacturers (Sproles, 1979). Creative thinking must be used to confront and solve the quantum problems that exist throughout the supply chain in apparel industry (Marcketti & Karpova, 2015). Fashion innovation begins with consumer's behavior towards dressing. Creative behavior in how clothes are used is linked to an individual's need for a certain product, and simply using an existing product in a new and novel way can be a source of innovation (Hirschman, 1984).

Thus, consumers can be highly creative and skilled in their ability to solve problems, and it is believed that alternative buying behavior can generate new ideas (Price & Ridgway, 1982). Consumer satisfaction helps with building a long-term relationship between marketers and customers, which in turn helps the process of product diffusion, especially for visual products such as fashion. And, celebrities' use of fashion also affects the consumer's clothing behavior and purchasing of new products (Shukre & Dugar, 2013).

There are some developmental studies concerned with consumer needs and desires towards traditional fashion. One such study is Al-Aboudi (2008) which examined a range of Saudi men's clothing designed to fit the needs of contemporary youth by determining young people's opinion in developing the Saudi "Thobe," a traditional costume for men to limit the reasons young people give to prevent them wearing it. Fairak (2013) also provided a development study that sought to identify the desire of brides to wear traditional dresses, and the possibility of integrating traditional hand embroidery with contemporary designs. Fairak's research suggests that combining the old with the new can be one method for keeping cultural heritage alive.

The creative industries develop and make new works of art, which can then be used by the manufacturing and service sectors. For example, similar versions of new innovative pieces can be mass-produced for the mainstream market. This also applies to the fashion industry, where innovative collections are copied and adapted to create clothes for well-known everyday brands (Age, 2008).

Innovations can also be nurtured and developed by adopting a problem-solving approach. These problems can be real or invented if there is a need to find strong and stable solutions to produce innovative and creative designs (Stacey, Eckert, & Wiley, 2002). Multimedia design programs can also be effective in developing fashion design skills (Al-Nail, 2007). (Chin-Min, Wang & Ying-Li, 2015) applied eight of the 40 TRIZ principles (numbers 12- 15- 23- 25- 29- 32- 33- 34) to design customized fashion handbags, which is an interesting development in finding new business opportunities in fashion. After using TRIZ, Benetton Inc. adopted principle 10 to solve cost and time production problems to ensure that fashion is presented on time. Moreover, Benetton Inc. considered using TRIZ as an effective strategy to solve other business problems (Mann, 2002). Any technical system tends to reduce costs, and any technical system through its duration tends to become more ideal (Jiang, 2010). The study of traditional costumes and accessories has also inspired creative new designs. One group of scholars have documented the distinctive features of traditional Saudi fashions, such as shape, lines, decorations, colors, fabrics, and implementation (Ashour, 1995) (Yamani, 1997); (Al-Hulayel, 2007); (Al-Suwaida, 2007). Yet, their work has not broadened the spread of their designs in Saudi society regardless of its uniqueness.

Thus, it is important to try to adopt TRIZ principles because they rely on logic and data, and could help in traditional fashion. Furthermore, these principles can be applied to a range of traditional costumes.

From this discussion of the literature, the importance of recognizing another category of women has become evident because women shape consumer's opinions toward traditional Saudi fashion in general by considering the positive elements that help in their spread and negative elements that do not. Bye (Bye, 2010). explained that there is a need for essential solutions. Because of the rising complexities that hinder creative practices in clothing design, this research adopted a creative approach.

3. Objectives

The objectives of the research are to restrict the reasons behind the limited use by Saudi women of traditional costumes by identifying fashion's negative features while identifying the current, most preferred pieces of clothes women want to wear. The research also seeks to find creative solutions to traditional clothes using the TRIZ principles to fit in with women's requirements in the current era. Finally, a design for a contemporary fashion collection that reflects traditional Saudi clothing details is provided.

4. Methodology

4.1 Research methods:

A descriptive analytical method was applied to determine the commonly used garments among women in the Saudi society, and to restrict the reasons behind the limited use of traditional clothing. Furthermore, Systematic Innovation TRIZ principles were also applied to solve traditional fashion problems, and implement solutions in designing a collection of contemporary fashion with features of the traditional fashions of two tribes: Bani Malik and Bani slaim.

4.2 Population and sample sizes

In 2016, a total of 224 female students and faculty members in the Department of Fashion Design and

finding creative solutions in the contemporary design of clothing that reflects the cultural heritage of Saudi Textile at Princess Nourah Bint Abdul Rahman University were chosen as the research population. To find the sample size Equation (1) below was used where N is the population size, e is the margin of error, and z is the z-score based on 95% level of significance. The sample size was calculated to be 142 individuals.

$$Sample\ Size = \frac{\frac{z^2 \times p(1-p)}{e^2}}{1 + \left(\frac{z^2 \times p(1-p)}{e^2 N}\right)} \quad (1)$$

4.3 Research Tools

1. **Two Questionnaires** were set of questions used to complement the TRIZ forty principles. The first questionnaire consisted of four open-ended questions that aimed to find preferred clothing types, fabrics, also positive and negative factors of Saudi costumes. The second questionnaire consisted of 8 questions using a five-point Likert scale to evaluate the application of TRIZ principles in finding creative solutions to prevent the extinct of cultural heritage in traditional clothing and help in its spread.
2. **TRIZ 40-Principles:**(as shown in Figure 1) 1/Segmentation, 2/Taking Out/Separation, 3/Local Quality, 7/Nested Doll, 10/Preliminary Action, 15/Dynamization, 19/Periodic Action, 21/Skipping, 24/Intermediary, 25/Self Service, 30/Transparent Materials, 32/Changing the Color, 34/Discarding and Recovering, and 35/ Parameter Changes. Furthermore, TRIZ methodology steps in problem solving were used (Altshuller, Clarke, Shulyak, & Lerner, 2005); (Jiang, 2010); (Helena & Navas, 2013).
3. **Business Matrix 45:** Using the matrix of positive and negative factors to determine the appropriate TRIZ principles to solve creative technical questions or problems (IFR Consultants Ltd, 2016)



Concept design; TRIZ (Teoriya Resheniya Izobreatatelskikh Zadatch)

TRIZ – 40 Principles

| | |
|--|--|
| 1 Segmentation | 21 Skipping |
| 2 Taking out | 22 Blessing in disguise |
| 3 Local quality | 23 Feedback |
| 4 Asymmetry | 24 Intermediary |
| 5 Merging | 25 Self-service |
| 6 Universality | 26 Copying |
| 7 Russian dolls | 27 Cheap short-lived objects |
| 8 Anti-weight | 28 Mechanics substitution |
| 9 Preliminary anti-action | 29 Pneumatics and hydraulics |
| 10 Preliminary action | 30 Flexible shells and thin films |
| 11 Beforehand cushioning | 31 Porous materials |
| 12 Equipotentiality | 32 Colour changes |
| 13 "The other way round" | 33 Homogeneity |
| 14 Spheroidality - Curvature | 34 Discarding and recovering |
| 15 Dynamics | 35 Parameter changes |
| 16 Partial or excessive actions | 36 Phase transitions |
| 17 Another dimension | 37 Thermal expansion |
| 18 Mechanical vibration | 38 Strong oxidants |
| 19 Periodic action | 39 Inert atmosphere |
| 20 Continuity of useful action | 40 Composite materials |

Fig. 1 TRIZ-40 Principle.

Source (TRIZ 40 Design Principle - University of Southampton)

4.4 Research procedures

1. Determine the level of innovation: There are five levels of innovation: routine solutions, small corrections in existing systems, major improvements that solve contradictions in typical systems of a particular branch of industry This is where creative design solutions appear, solutions based on the application of new scientific principles that “replace the original technology with the new technology,” and innovative solutions based on the discoveries that were not discovered before. The goal of TRIZ is to assist in the development of design tasks in three or four levels (Helena & Navas, 2013, p. 76)
2. Contradictions arise by using the matrix of positive and negative factors to determine the appropriate TRIZ principles needed to solve creative technical questions or problems. Contradictions were identified from the results of the questionnaire, which was distributed to a sample of female students and faculty.
3. The ideal solution, the “ideal rule,” means that any technical system tends to reduce costs. Besides, any technical system over time tends to become more ideal. The optimal solution can be

determined after understanding the direction of the technical development of the system, and later seeking verification of the results by using the appropriate TRIZ principles to reach an ideal solution through the matrix of Business Matrix 45 (IFR Consultants Ltd, 2016).

The objective here is to develop technical systems to propose appropriate solutions for the dissemination of cultural heritage in traditional fashion, and to design contemporary fashion collections with features of traditional fashion.

5. Results

5.1 Questionnaire results

The research sample group’s opinions on traditional costumes indicated that: 66.90 % of participants believe that traditional clothing is characterized by its colors, beautiful decoration, and how it was adorned, 15.49% found that it provides modesty, and 12.68 % that it provides convenience. Just 4.93% of women

found that traditional fashion is characterized by its broad design (see Table 1).

Table 1 Reasons for Wearing Traditional Clothing

| Due to used | <i>Colors, decoration, and how it was adorned</i> | <i>Provides modesty</i> | <i>Provides comfort</i> | <i>Characterizing the design lines</i> | <i>Total</i> |
|-------------------|---|-------------------------|-------------------------|--|--------------|
| <i>Iterations</i> | 95 | 22 | 18 | 7 | 142 |
| <i>Percent %</i> | 66.90% | 15.49% | 12.68% | 4.93% | 100% |

Participants who believe that the non-use of traditional fashion is high due to the high price and length of production time stood at 87%, while 21.83% believe

that traditional fashion is impractical, 21.13% said it was unvaried and does not keep pace with fashion, and 28.17% believe in causes (see Table 2).

Table 2 Reasons Not to Use Traditional Costumes

| Reasons not to use traditional costumes | The high price and length of product time | Impractical | Unvaried and does not keep pace with fashion | All causes | Total |
|---|---|-------------|--|------------|-------|
| Iterations | 41 | 31 | 30 | 40 | 142 |
| Percent | 28.87% | 21.83% | 21.13% | 28.17% | 100% |

Participants who prefer to use various types of clothes was 56.34%, while 33.10% prefer to use dresses, 10.56% prefer using trousers and blouses, and

71.8% prefer using a variety of fabrics in clothes, while 28.2% prefer specific fabrics based on (see Table 3).

Table 3 Favorite Clothing Types & Fabrics

| Sorting | Favorite Clothing Types | | | | Favorite Fabrics | | |
|------------|-------------------------|----------|---------------------|-------|------------------|------------------|-------|
| | Variety | Dress up | Slacks and a blouse | Total | Variety fabrics | Specific fabrics | Total |
| Iterations | 80 | 47 | 15 | 142 | 102 | 40 | 142 |
| Percent | 56.34% | 33.10% | 10.56% | 100% | 71.8% | 28.2% | 100% |

5.2 Classification and analysis by a Business Matrix 45

Based on these results, a Business Matrix 45 (IFR Consultants Ltd, 2016) was used to solve the negative elements of traditional costumes.

In Table 4, the contradiction matrix of positive and negative factors of Saudi costumes is given a Worsening Features in (Production factor: 7/ Production Cost, 8/Production Time) and (Systems Factor: 27/Convenience, 28/Adaptability/Versatility). Whereas an Improving Features in (Production factor:

6/Production Spec) and (Systems factor: 32/Stability). TRIZ principles (1/Segmentation, 2/Taking Out/Separation, 3/Local Quality, 7/Nested Doll, 10/Preliminary Action, 15/Dynamization, 19/Periodic Action, 21/Skipping, 24/Intermediary, 25/Self Service, 30/Transparent Materials, 32/Changing the Color, 34/Discarding and Recovering, and 35/ Parameter Change) can be used to achieve creative solutions to address the problems shown. Positive factors in traditional costumes can be adopted in designing a variety

of contemporary fashion collections; negative factors need to be isolated or discarded (see Table 5).

Table 4 Principles of TRIZ Used to Solve Traditional Costumes Problems Using Business Matrix 45

| Worsening Feature Improving Feature | | Production | | Systems | |
|--|--|-------------------|-------------------|--|---|
| | | 7/Production Cost | 8/Production Time | 27/Convenience | 28/Adaptability/Versatility |
| | | High Cost | Time Execution | Clothes Weight Width & Length Exaggeration | Fabric, Materials Decoration, Undiversified |
| (Production) 6/Productio n Spec/ | Decoration Methods | 15 25 | 1 35 | 2 15 | 3 15 |
| | | 10 35 | 21 15 | 7 10 | 30 25 |
| (Systems) 32/Stability | Decoration Lines, Color, Construction Lines | 10 1 | 10 15 | 32 35 | 31 30 |
| | | 35 24 | 2 19 | 30 25 | 3 2 |

Table 5 Proposed Creative Solutions for Traditional Costumes Using TRIZ Principles

| Positives | Negatives | Principle's number | Proposed solutions for designing costumes |
|---|--|--------------------|--|
| Modesty Simple construction lines | Lack of diversity in clothes | 35 | Use a variety of decent clothes |
| | Failure to keep pace with fashion trends in lines and fabrics. | 30, 2 | Use of contemporary clothes |
| | Exaggerating in length and width & inconvenience | 3 | Use of lightweight materials |
| | | 34 | Adjust the width and length. Recover discarding elements in a new way |
| Concentrating on motif's decoration in costumes | The weight of costumes | 2, 1 | Isolate distinctive decorative motif |
| | Exaggeration in the decoration. | 35 | Simplify of the decoration |
| | | 3, 19 | distribute decorative motifs creatively |
| Using hand crafts on costume decorating | High production cost | 2, 3 | Reduce the amount of hand embroidery |
| | Heavyweight costume | 35 | Replace heavy material with light weight material. |
| | Long production time | 10, 15 | Use traditional decoration motif in manufacturing trims, accessories, woven, and printed or embroidered fabrics. |
| | | 19, 21 | |
| Using saturated colors in costumes decoration | Lack of adoption fashion color's trends | 35 | Adopt color trends in fashion. using wash and wear fabrics |
| | | 32 | Adopt decorative traditional colors in contemporary clothes |
| | | 24, 7 | |

5.3 The Appropriate TRIZ principles for solving traditional costumes

Figure 2 shows that the TRIZ principle 15/dynamization is appropriate to maintain the positive factors of traditional fashion by developing a system of traditional costume production while reducing difficulties such as length of time and high cost of production, inconvenience, and inadaptability of designs for each item, requirements, and fashion trends. This is achieved by converting the manual work of producing traditional decoration to machine work, either by using machine embroidery, jacquard woven textile, or printing. This can be achieved by focusing the positive factors in decorative motif design, its implementation and colors, dividing it into decorative units "1/Segmentation", then repeating and coordinating it by using Digital Systems "25/Self Service" to produce decorative textiles either by embroidering, printing, or jacquard woven, using principle 7, 24,30.

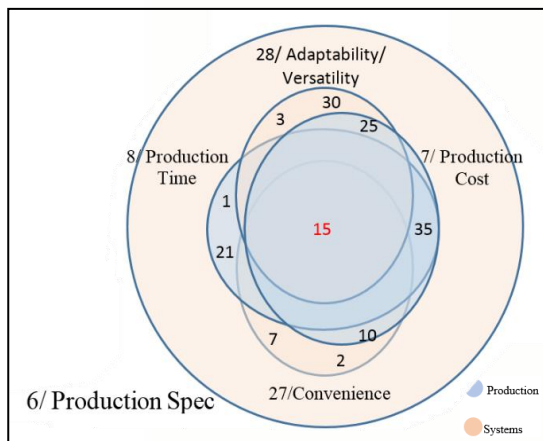

Fig. 2 Appropriate TRIZ Principles for Solving Traditional Costumes' Disadvantages to Maintain Its Decorative Style

Figure 3 shows appropriate TRIZ principles for solving traditional costumes' problem and its heritage stability, which includes color. Production lines and decoration lines using principle 35/Parameter Changes, for example, can replace heavy material with light weight material, use a variety of decent clothes, and use contemporary clothes. These principles are supported by using one or more of the following principles 2/Taking Out/Separation of negative factors, and using positive factors by applying principle 10/Preliminary Action for example: they can use traditional decoration motif in manufacturing trims, accesso-

ries, woven, and fabrics, and principle 30 with thin and flexible materials.

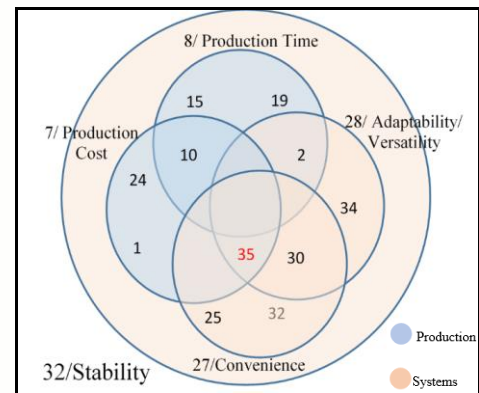

Fig. 3 Appropriate TRIZ Principles for Solving Traditional Costumes' Problem and Its Heritage Stability

Figure 4 shows appropriate TRIZ principles to eliminate traditional costumes' disadvantages in the long term using principles 15,10, and 35. These principles are supported by using one or more of the following principles 1,2, 25 and 30. This can be achieved by isolating the positive factors in decorative motif design, its implementation and colors, dividing it into decorative units" 1 / Segmentation", then repeating and coordinating It by using computer "25/Self Service " on Lightweight fabrics, Trims or Accessories. By using lightweight and fine materials in textile printing jacquard woven fabric or embroidering method "30/Transparent materials".

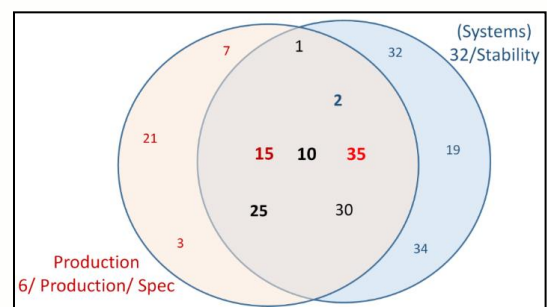

Fig. 4 Appropriate TRIZ Principles to Eliminate Traditional Costumes' Disadvantages in the Long Term

5.4 The application of Innovative solutions for designing contemporary fashion collections using features of traditional costumes of Bani Malik and Bani Slaim tribes

In Figure 5, the first collection designed using TRIZ principles shows that the designs were made by applying a selection of TRIZ principles to come up with a contemporary afternoon collection. The collection was inspired by the aesthetic values of the Bani Malik tribe's costumes, which are modesty, beauty, saturated colors, and diversity in decoration. Based on the questionnaire results, costumes' negativities were discomfort, intensity of decoration, and failure to adapt to fashion trends. Therefore, a set of TRIZ principles were adopted to eliminate the negative features and to transform them into a modern fashion collection that can be

produced wholesale. Eight principles were used to design the collection shown in Figure 5. Principle 35/ Parameter Changes inspired the replacement of the long dress with a variety of contemporary clothes. Next, principles 2, 25, and 30. By substituted heavy fabrics in to thin fabric that are "wash and wear." Finally, colors were changed, based on principle 32 As for manufacturing improvement, principles 1, 15 and 10 were adopted to divide the decorations into several smaller parts, transfer handmade work into mechanical work, and to manufacture ready-made beaded trims to maintain the aesthetic values of Bani Malik's costumes.



Fig. 5 Contemporary Afternoon Fashion Collection, Inspired by the Aesthetic Values of Bani Malik Tribe

Figure 6 shows the second designed collection from the Bani Malik tribe's costumes. The second designed collection aims to give a variety of all-day contemporary clothes. The designs were also inspired by the Bani Malik tribe's costumes. The

main principles adopted in collection 1 were 7/, 34. The two principles allowed for creatively recounting parts of the costumes then printing them onto contemporary fabrics.



Fig. 6 Contemporary All-day Fashion Collection, Inspired by the Aesthetic Values of Bani Malik Tribe.

Figure 7 shows the third collection inspired by Bani Slaim tribe's costumes. The third designed collection is a set of contemporary evening wear inspired by the aesthetic values of the Bani Slaim tribe. As per the questionnaire, the costumes' negatives are an exaggerated width in the overall garment as well as the sleeve's length and width. The applied TRIZ principles aimed to eliminate the negatives while aiming to keep the positive attributes, which are modesty, beauty, and diversity in

decoration. To start, principle 35/ Parameter Changes was applied to disseminate the cultural heritage of the costume and design a modern collection that considers women's preferences. Also, it contributes to benefitting from an applique unit at the upper sleeves area by applying it to produce fabrics and woven trims that can be printed or mechanically embroidered. The parts can then be distributed in attractive positions using principles 7, 15, and 3.



Fig. 7 Contemporary Evening Wear Collection, Inspired by the Aesthetic Values of Bani Slaim Tribe.

Figure 8 shows the fourth designed collection, which consists of diverse contemporary all-day clothes also inspired by the Bani Slaim tribe's costumes. It was designed by applying TRIZ principles aimed at eliminating the negatives and retaining the positive attributes, which are modesty, beauty, and diversity in decoration. To start, principle 35 was applied to disseminate

the cultural heritage of the costume and design a modern collection. Also, it benefits from an appliquéd unit at the upper sleeve area by applying it to produced fabrics and woven trims that can be printed or mechanically embroidered. The parts can then be distributed in attractive positions using principles 7, 10, 15, and 3.

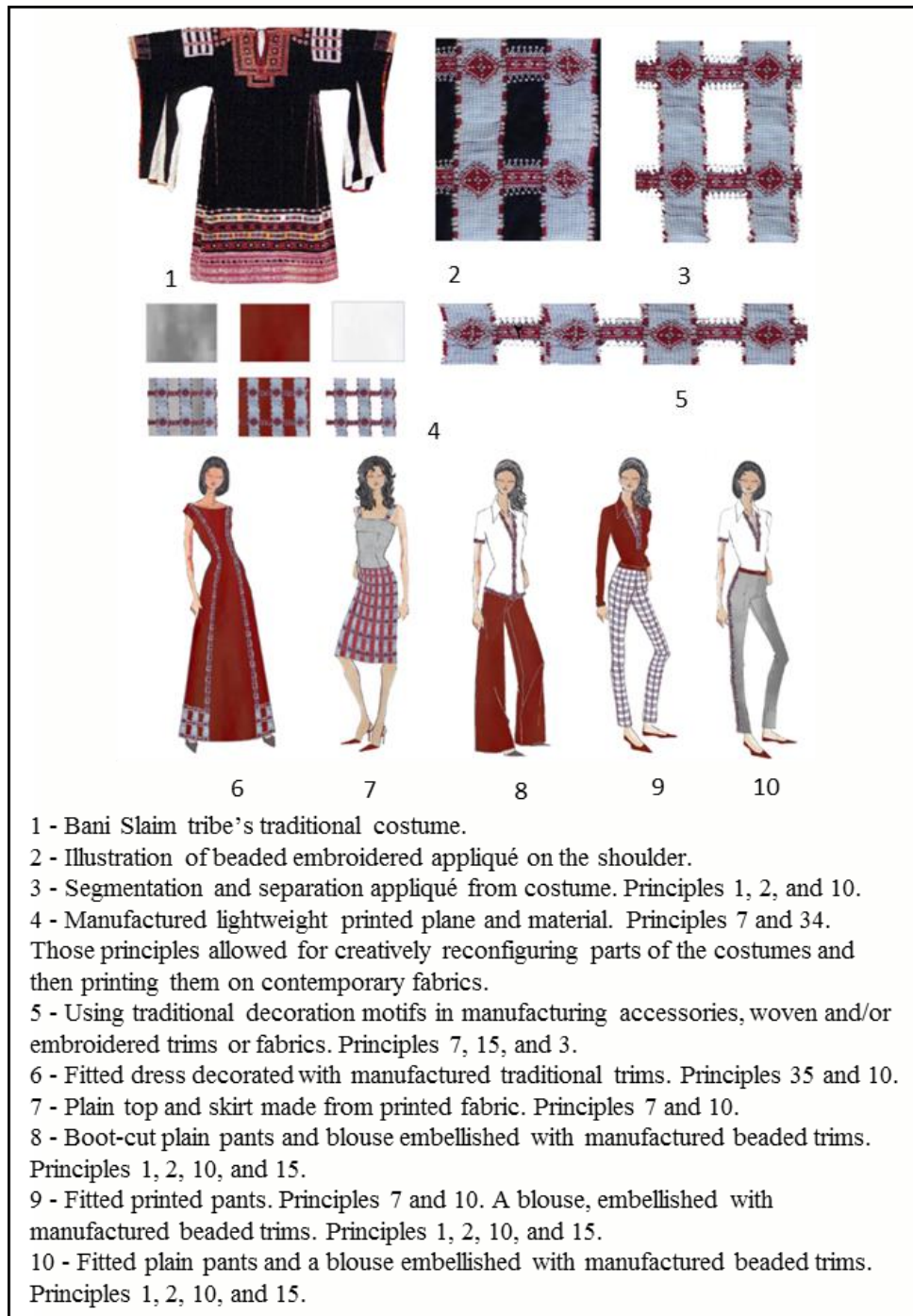

Fig. 8 Contemporary All-day Fashion Collection, Inspired by the Aesthetic Values of Bani Slaim's Tribe

5.5 Evaluation solutions to the TRIZ principles: Consumers' Opinions about the New Fashion Collection Inspired from the Traditional Outfits of the Bani Malik and Bani Salim Tribes

Fig 9. shows that for the fashion designs inspired by Bani Malik and Bani Salim tribes, the cumulative approval percentage for the inclusion of traditional costume decoration and traditional dress colors was 83.90-90.26% and 81.9-93.63%, respectively. These percentages indicate that principle 10 contributed to the use of the cultural heritage of traditional fashion with the use of principle 2 to isolate the negative factors such as loose long dress and only focusing on the positive factors such as decoration by using principle 1 to fragment the decorations into units. In addition, principle 19 is used for the repetition of the decoration units, and principle 34 is employed to change the colors of the manufactured traditional fabric trims or decorations to modern fashion colors.

Moreover, 86.90-79.40% accepted the variety of designs and their suitability for their needs. Likewise, 82.03-77.90% agreed on the suitability of the collection for events and activities. This is an indicator of the effectiveness of using principles 35, 34, 30, and 32 in

addressing the disadvantages of traditional costumes (which include the lack of variety in designs and fabrics, exaggerated looseness, and heavy weight) by changing the traditional cloth properties via diverse designs, fabrics, transparency, and colors to suit the requirements of the present era.

Furthermore, 80.52-89.14% of the study sample considered the designs in line with fashion trends. Additionally, 88.39-89.51% and 86.90-86.14% agreed on the simplicity of designs' lines and suitability of size and placement of the decorations, respectively. This shows the usefulness of using principles 25, 7, and 3 to achieve a quick spread of the cultural heritage of traditional fashion.

Moreover, 85.67-79.40% of the study sample stated their willing to buy these designs if they are readily available in the market. This highlights the importance of principle 15 in preventing the extinction of the cultural heritage of traditional fashion and helping its spread and continuity through mass production.

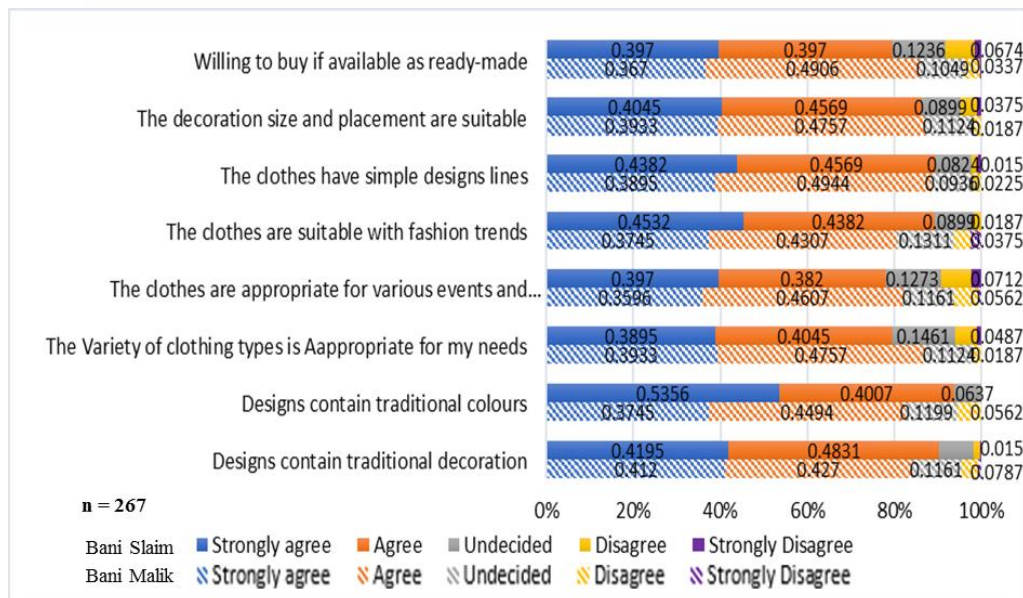

Fig. 9 The opinions of consumers about contemporary fashion designs inspired by Bani Malik and Bani Salim tribes

6. Discussion:

The colors, decorations, and adornments of traditional Saudi costumes are all highly positive factors in traditional costumes. On the other hand, high cost, time execution, clothes weight, width & length exaggeration, decoration materials, and undiversified designs & fabrics are considered as negative factors in traditional costumes, which limits the spread of traditional costumes. Fedá (2003) Explained that some traditional clothing can require two to five months for its execution, depending on the amount of embroidery and the skill of the women who embroider the garments. Traditional clothes can disrupt movement due to its heavy weight and the use of real materials in decorating, such as golden and silver lead beads and coins

Women prefer the diversity in the use of clothes and fabrics to achieve comfort and adaptability within fashion trends, and to meet their needs. These specifications are not available in traditional costumes, which has led to the demise of traditional costumes Al-Bassam (1985) Confirmed that some of the fashion heritage elements aspects are considered useless because they conflict with modern circumstances by making the necessary adjustments to the positive heritage elements, and using it as an important inspirational source.

Choosing the suitable TRIZ principle depends on problem. Therefore, it was found through analysing the contradiction matrix that the creative solution for spreading positive traditional costumes' elements is achieved using principle 35/ Parameter Changes. Whereas the Benetton Inc. adopted principle 10/Preliminary Action to solve cost & time production to ensure that fashion is presented in time (Mann, 2002). Moreover, principle 35/ Parameter Changes is supported using the ideal solutions in principles 15/Dynamization and 10/Preliminary Action for reducing product cost and time. Helena & Navas (2013) Explained that any technical system tends to reduce costs, and any technical system through its duration tends to become more ideal.

This study was limited to finding the principles of Therese that can be applied and proposing design ideas to show how to reduce the disadvantages of traditional fashion. It also supports and improves the positive aspects to meet the requirements of the current era and fashion trends, as well as to preserve the cultural heritage of fashion and dissemination. Therefore, the study requires the concerted efforts of:

1. researchers and those interested in preserving the cultural heritage of the traditional Saudi

costume to establish a digital library, including drawings and models of the types and forms of fashion and aesthetic values;

2. the practitioners of fashion design taking advantage of the principles of Therese to design costumes that match the requirements and needs of the era and fit all age groups, inspired by the traditional costumes of various kingdom regions.
3. fashion producers to contribute to the conversion of Saudi cultural heritage costumes from individual work to industrial production. This must start with basic models, special details, and identification of materials and production processes and end in production and marketing.

7. Conclusion

Our results show that the colors, decorations, and adornments of traditional Saudi costumes are all highly positive factors, and reasons why women would wear them. Negative factors, which limit the wearing of traditional clothes, include high cost and long production time, impracticalities, such as the heavy weight of the clothing and exaggerated widths and lengths of the designs, and the lack of variety in styles and fabrics.

Once we determined the factors that limit women's use of traditional costumes in modern Saudi society, we compiled the results in Business Matrix 45. We then applied 14 TRIZ principles to achieve creative solutions to address the problems found: 1/Segmentation, 2/Taking Out/Separation, 3/Local Quality, 7/Nested Doll, 10/Preliminary Action, 15/Dynamization, 19/Periodic Action, 21/Skipping, 24/Intermediary, 25/Self Service, 30/Transparent Materials, 32/Changing the Color, 34/Discarding and Recovering, and 35/ Parameter Changes.

TRIZ principles linked to various aspects of design and production can be used to achieve the desired outcome for the problems identified by other TRIZ principles. For example: one or more of the TRIZ principles linked to production (10, 25, and/or 35), can be used to achieve TRIZ principle 15/Dynamization; one or more of the TRIZ principles linked to Systems Factor: (1, 2, 10, 15, 25,30,32 and/or 34) can be used to achieve principle 35/ Parameter Changes; or principle 1 can be used to achieve principle 10/Preliminary Action.

We have demonstrated that TRIZ principles can be used to help solve some of the negative elements of

traditional Saudi costumes that prevent their use by women in modern Saudi society. Applying TRIZ principles can aid in creative thinking to develop innovative solutions for designing appealing contemporary fashion collections that are feature elements of traditional costumes.

This study shows that it is important to balance cultural heritage with the requirement for clothes that are comfortable, practical, and fashionable for use in modern society. Further work is required to determine the level of customer satisfaction with contemporary designs adapted from traditional costumes. Clothes, then, need to be designed so they can be mass produced to ensure a long-term legacy of traditional design elements.

8. Acknowledgements

This research was supported in part by grants from the Deanship of Scientific Research, Princess Nourah bint Abdulrahman University, Riyadh. Ref number: (36- 131 - ص).

9. References

- Aage. (2008, Oct 1). *From Fashion to Design: Creative Networks in Industrial Districts*. *Industry and Innovation Journal*, 5(Taylor and Francis Online), p. 475:491. doi:10.1080/13662710802373791
- Abu Jado, S. M. (2007). *Practical applications of developing creative thinking using the theory of creative problem solving* (Vol. Second). Amman, Jordan: Dar Al Shorouk.
- Abu Jado, S. M., & Nofal, M. B. (2017). *Teaching Thinking Theory and Practic* (Vol. 6th). Amman, Jordan: Al-Maseera for printing, publishing & distribution.
- Al- Bassam, L. S. (1985). *Traditional heritage of women's clothing in Najd*. Doha- Qatar: Popular Heritage Center.
- Al-Aboudi, W. A. (2008). *Attitudes of Saudi youth towards the modern Design of Saudi Thob in Riyadh*. *Riyadh, Saudi Arabia*: (Unpublished master's thesis). College of Home Economics and Art Education.
- Al-Hulayel, N. (2007). *Traditional bride Costume in Saudi Arabia & its implication in contemporary fashion*. Riyadh, Saudi Arabia: (Unpublished master's thesis). College of Home Economic and Art Education.
- Al-Nail, N. (2007). *proposed design program using multimedia for the development of innovative thinking in fashion design skills*. Riyadh, Saudi Arabia: (Unpublished master's thesis) College of Home Economics and Art Education.
- Alrafe, Y. A. (2008). *The impact of the principles of some innovative solutions to problems according to the theory*. Makkah, Saudi Arabia: (Unpublished doctoral dissertation). College of Education, Umm Al-Qura University.
- Al-Suwaida, N. A. (2007). *The effect of designing, using the method of modelling on the measurement sample, in enriching designs derived from traditional costumes*. Riyadh, Saudi Arabia.: (Unpublished master's thesis). College of Home Economics and Art Education.
- Altshuller, G., Clarke, D. W., Shulyak, L., & Lerner, L. (2005). *TRIZ Keys to Technical Innovation*. (L. Shulyak, & S. Rodman, Eds.) USA: NICAL INNOVATION CENTER WORCESTER. Retrieved from MA TEC www.triz.org
- Ashour, O. S. (1995). *Creating decorative designs based on the employment of Rhythmic Systems For a selection of Saudi folkloric costume decorations and accessories*. Makkah, Saudi Arabia: (Unpublished master's thesis), Umm Al-Qura University.
- Barry, K., Domb, E., & Slocum, M. S. (2017, March 4). *What-is-triz*. (K. Barry, Editor) Retrieved from <http://triz-journal.com/triz-what-is-triz/>
- Bye, E. (2010, June 21). *A Direction for Clothing and Textile Design Research*. *Clothing & Textiles Research Journal*, First (23), pp. 205-217. doi:10.1177/0887302X10371505
- Chin-Min, L., Wang.w., Y., & Ying-Li., Y. (2015, 03 09). *Innovative Design of Customized Fashion Hand bags*. *International Journal Systematic Innovation*, 4, p. 1:19. Retrieved from <http://www.IJoSI.org>
- Fairak, D. A. (2013). *Traditional hand embroidery for wedding dress in Saudi Arabia: Makka and Madinah*. (Master's thesis). University Technology MARA: Retrieved Nov 21, 2016, from <http://ir.uitm.edu.my/id/eprint/15554>
- Feda, L. A. (2003). *Adornments Styles of traditional clothes of women in Hijaz Region*. "Comparative study. Riyadh, Saudi Arabia: (Unpublished doctoral dissertation) College of Home Economics and Art Education.
- Helena, V. G., & Navas. (2013, March 13). *TRIZ: Design Problem Solving with Systematic Innovation*. (D. A. Coelho, Editor) doi:10.5772/55979

- Hirschman, E. C. (1984, March 1). *Experience seeking: A subjectivist perspective of consumption*. Journal of Business Research, 1, p. 115:136. doi:10.1016/0148-2963(84)90042-0
- Jiang, F. (2010, August 24-27). Application idea for TRIZ theory in innovation education School of Mechanical and Electric Engineering. Computer Science and Education (ICCSE), 2010 5th International Conference. Hefei, China: IEEE. Retrieved from <http://ieeexplore.ieee.org/document/5593787/>
- Mann, D. C. (2002, May 8). *Systematic Win-Win Problem Solving In A Business Environment*. (D. C. Mann, Producer) Retrieved 2017, from Triz-journal: <https://triz-journal.com>
- Marcketti, S. B., & Karpova, E. (2015, July 1). *Editors' Note: creative thinking and problem solving in the textiles and clothing discipline*. Clothing & Textiles Research Journal, 3, p. 163:166. di: 10.1177/0887302X15579991
- Price, L. L., & Ridgway, N. M. (1982). *Use Innovativeness, Vicarious Exploration and Purchase Exploration: Three Facets of Consumer Varied Behavior*. American Marketing Association Educators' Conference Proceedings (pp. AMA, 56-6). Chicago: B. Walker.
- Savransky, S. D. (2000). *Engineering of creativity: Introduction to TRIZ methodology of inventive problem solving*. Florida: CRC PLLC.: Baco Renton.
- Shukre, A., & Dugar, N. (2013, April). *Effect of Celebrity Endorsements on Consumer s 'Decision-Making Processes*. International Journal of 360o Management Review, 01, pp. 1-17. Retrieved from <http://www.ij360mr.com>
- Sproles, G. B. (1979). *Fashion: Consumer Behavior toward Dress*. Minneapolis: Burgess.
- Stacey, M., Eckert, C., & Wiley, J. (2002). *Expertise and creativity in knitwear design*. International Journal of New Product Development and Innovation Management, 4(1), 49:64. doi:10.1.1.83.6455&
- Tayeb, G. (2016). *Innovation in the marketing mix between the challenges and possible solutions: Case* IFR Consultants Ltd. (2016). *Business Matrix, physical contradiction resolution strategies*. Retrieved from www.systematic-innovation.com
- study of the National Telecom Algerie*, Oredu. Retrieved from Mandumah: <http://search.mandumah.com/Record/752388>
- TRIZ 40 Design Principle* - University of Southampton. (n.d.). Retrieved from <https://www.southampton.ac.uk>:
- Yamani, S. (1997). *Makkah women dress as a source of heritage in designing and implementing contemporary leather craft items, and their advantage in teaching art educ*. Makkah, Saudi Arabia: (Unpublished doctoral dissertation). Faculty of Home Economics, Umm Al Qura University.

AUTHOR BIOGRAPHIES

Wafa Hassan Shafee is an Associate Professor of Fashion & Textile Design. College of Art & Design, Princess Norah Bint Abdulrahman University, Riyadh, Saudi Arabia. She has been a faculty member since 1985. Her research interest lies in the costume and creative fashion design and she has authored 3 books, also she supervised PhD and MA dissertations

Laila Feda is an Associate Professor of Fashion & Textile Design. College of Art & Design, Princess Norah Bint Abdulrahman University, Riyadh, Saudi Arabia. She has been a faculty member since 1988. She gained Her Doctoral dissertation in 2003. Her research interest lie in the area of folkloric costume and creative design, ranging from theory to design to implementation.

A Study on Design Thinking Based Creative Product Design Process in a Design Project

Chun-Ming Yang*, Thu-Hua Liu and Ya-Yi Zheng

Department of Industrial Design, Ming Chi University of Technology, Taiwan, ROC

*Corresponding author, E-mail: cmyang@mail.mcut.edu.tw

(Received 12 October 2017; final version received 20 March 2019)

Abstract

This study aimed to propose a process of creative action that is based on a version of design thinking process with six stages (i.e., understand, observe, point of view, ideate, prototype, and test) to promote T-shaped talents in design education in specific, and general education in general. The innovative process first started with literature research, field study, and brainstorming to understand and observe the target audiences resulting in inspired viewpoints, followed by nine-window method and C-sketch technique to develop creative solution concepts, and then scenario building and storytelling with both AEIOU and 5W1H techniques were introduced to help provide distinct perspectives and profound knowledge about the solution concepts with target audiences in mind. Finally, the chosen resolution was realized by prototyping and testing. A case study was demonstrated to present how this newly developed approach works.

Keywords: Design thinking, Creative thinking tools, Product design, T-shaped talent

1. Introduction

Leonard-Barton (1998) mentioned that major enterprises (e.g., Microsoft, HP, and Motorola) prefer to recruit T-shaped talents, which involve expertise and experience in a certain field as well as the capacity to collaborate across different fields (Hansen, 2010). Brown (2008) also observed that with increasing complexity in products, services, and experiences, interdisciplinary collaborators can replace genius-type talents in the past, and that such talents and capabilities are the personality traits that make a design thinker.

Design thinking places emphasis on systematic thinking processes for user-centered designs and the utilization of the 3Is (inspiration, ideation, and implementation). With constant interactions in both divergent and convergent thinking, design thinking produces innovative solutions that meet user needs (Brown, 2008; Brown & Wyatt, 2010). However, without the aid of suitable design or creative tools, difficulties in problem definition and overly limited concepts become common occurrences in conceptual development processes.

This study then employed the six steps of design thinking (understand, observe, point of view, ideate, prototype, test) proposed by d.school, Stanford University (Hasso Plattner Institute of Design at Stanford,

2007; Carroll, Goldman, Britos, Koh, Royalty, and Hornstein, 2010) as the framework and added appropriate creative tools to help develop innovative solutions which can take the consumer's needs, technological feasibility and business sustainability into account.

The remainder of this paper is structured as follows. Firstly, relevant literature review is introduced. This is followed by description of the Design Thinking based Product Design Process in details. Thirdly, a case study on EGF application is provided. Finally, conclusions are presented.

2. Literature Review

2.1 T-shaped Talents

David Guest coined the term "T-shaped talents" in his article "The Hunt is on for the Renaissance Man of Computing" (Guest, 1991). Leonard-Barton (1998) defined T-shaped talents as a group of people with both technological and commercial abilities and the capacity to analyze commercial data and provide better service alternatives. Tim Brown explained that the vertical stroke in the T symbolizes their expertise and experience in a certain field; in contrast, the horizontal stroke represents their interdisciplinary capabilities (Hansen,

2010). Having deep knowledge in their profession, T-shaped talent, drawn more attention and welcomed in the workplace, is also able to apply knowledge across situations and work collaboratively across disciplines. With both depth and breadth in their skills, T-shaped professionals are then the driving forces to innovation.

2.2 Design Thinking

The concept of design thinking was proposed by Bryan Lawson in the book *How Designers Think* and later applied by Nigel Cross and Peter Rowe to general education and architecture. Professor Rolf Faste began offering a design thinking course at Stanford University, and David M. Kelley incorporated management and commercial design into the course. As of today, design thinking has become a subject of interest in various fields. Design thinking is an iterative design process that encompasses three spaces (inspiration, ideation and implementation) (Brown, 2010). It emphasizes that designers must abandon their preconceptions and intuitive thinking patterns and divulges problems via observation and empathy. At the same time, they must also consider the needs and behaviors of the users, technology feasibility as well as the market sustainability of the product or service (Brown, 2008).

However, there are no specific procedures or tools for the design process (Brown, 2008; Brown et al., 2010). Without such aids to help define problems, it is easy for designers to be easily limited by their own preconceptions and interpret the problems from a personal perspective (Thomsen, 2013). Thus, the lack of appropriate tools to assist the concept development stage means that concept generation will easily be limited.

To address this issue, some general guidelines are developed. For example, six steps were developed for design thinking in education based on the applications of design thinking at the Stanford University's d.school and in K-12 exploratory education environments: understand, observe, point of view, ideate, prototype, and test (Carroll et al., 2010). Understand involves the use of interviews with experts and data collection to facilitate the understanding of the design problems and challenges while exploring background knowledge. Observe involves observing the environment with empathy and then presenting questions to the users to determine their needs. Point of view integrates the first three steps by setting target users and defining their needs. Ideate involves conceptual creation based on user needs. Prototype involves making a conceptual result, there has been an increasing attention on developing more effective methods for idea generation such

prototype using sketches, cardboard boxes, and models. The prototype is then tested, followed by conceptual optimization based on feedback (Carroll, et al, 2010).

2.3 9-window Method

The 9-window method is also known as Mandala, a term that comes from Buddhism, and is a nonlinear thinking tool. It uses the optimum stress in stimulation reactions and its interactions with relaxation psychology to break cognitive inertia and thereby train personal creativity (Imaizumi, 1999). In addition to helping users enhance their thinking level, it has systematic rules that help users become familiar with it quickly (Chen, 2005) and also effectively improves the associative abilities of users (Lin, 2006; Li, 2009). At present, common application of this method can be seen in education, artistic design, business administration, and spiritual inspiration.

The 9-window method can basically be divided into two forms: radiant thinking, which is a divergent thinking approach that assists in ideation using lateral thinking, and spiral thinking, which facilitates induction and organization using vertical thinking (Imaizumi, 1999; Li, 2009). The subject is first diverged and associated to the first layer, producing eight elements that are then diverged again to the second layer, which produces 64 elements. The number of layers in the 9-window method can be adjusted freely. Once the divergence is completed, convergence is performed. Four principles must be followed during the process: (1) make note of any inspirations, (2) fill the blanks with concise words, (3) focus on the completed 9-window method to continue gaining inspiration, and (4) discard any unsuitable concepts (Imaizumi, 1999).

2.4 Collaborative Design

One of the important factors in a design thinker's personality is the ability to work collaboratively. The best design thinkers need to work along together with other disciplines to collaborate their own significant experience. With design thinking, they have become the enthusiastic interdisciplinary collaborators (Brown, 2008). And one of the important spaces in design thinking process is ideation – the process of generating ideas that may approach potential solution (Brown, 2008). Some memory models in cognitive psychology indicated that in order to produce more ideas group should be more effective than individuals' efforts. As a

as Brainsketching, C-Sketch, 6-3-5, and Gallery Method (Linsey, Green, Murphy, Wood and Markman,

2005; Linsey, Clauss, Kurtoglu, Murphy, Wood and Markman, 2011). Among those methods, C-Sketch is considered as a progressive idea generation method especially in design related fields (Kulkarni, Summers, Vargas-Hernandez and Shah, 2001).

C-Sketch Method, a. k. a. Collaborative Sketching, is an effective idea generation method that was proposed firstly in 1993 in the Design Automation Lab (DAL) at Arizona State University (Shah, 1993). After that, it was renamed from 5-1-4 G to C-Sketch, which was an effort for the graphical brainstorming for solutions to design problems (Kulkarni, et al, 2001). C-Sketch Method is slightly different from 6-3-5 Method, which requires individuals to describe ideas through using words only, in requiring each participant describes ideas by sketching only in a limited time then pass to another participant (Linsey, et al, 2005; Linsey, et al, 2011). C-Sketch, through some experimental results, is shown to be more effective than other idea generation methods such as Gallery Method and Method 6-3-5 to perform the quality and variety of designs (Kulkarni, et al, 2001).

3. Design Thinking Based Product Design

This study integrated design thinking initiatives and creativity tools to develop a design thinking based product design process. The six steps of design thinking proposed by Carroll et al. (2010) (understand, observe, point of view, ideate, prototype and test) served as the core framework. Different creative tools were placed in the various steps so as to help users complete the tasks in each step. In understand, users can understand the problems and challenges via data collection and expert interviews and thereby quickly grasp relevant background knowledge. In observe, they conduct actual market research and interviews and divulge customer needs as well as usable technologies and products. In point of view, users integrate and analyze data to clarify user needs and design problems. In ideate, they use the 9-window method to diverge idea combinations and create sketches and employ AEIOU and 5W1H to define the usage environment, functions, and target customers of the design concepts. Then, they use scenario-based design to depict character features and scenario stories to generate user-centered design concepts. Finally, the prototype is tested to help users in producing design solutions that accept technical limitations and fulfill user (market) needs. The details of the procedure are as shown below, and Fig. 1 displays a flowchart of the design thinking process.

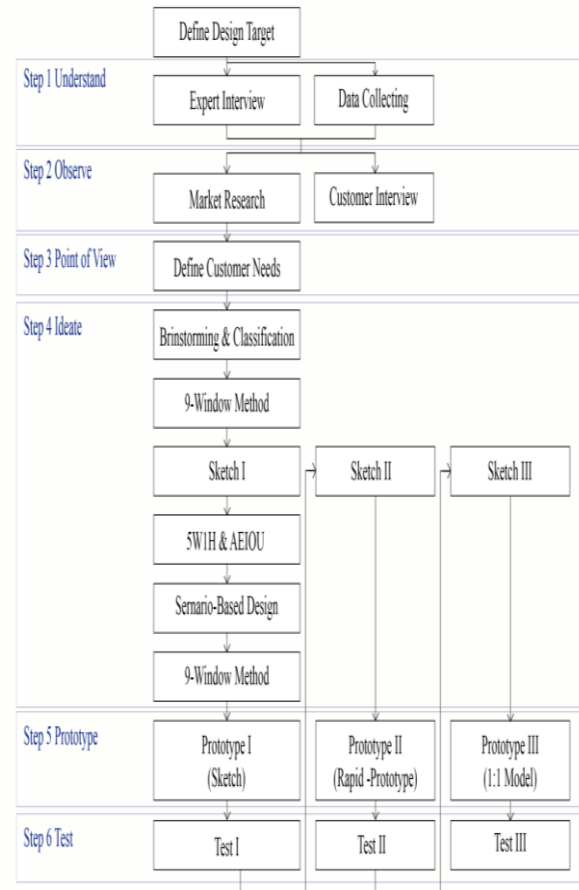

Fig. 1 Framework of this study

Step 1 Understand: After the design goal has been set, this step is divided into two phases to help users understand the problems and challenges in the field: (1) search for relevant references and data based on three questions: what is it, what can it do for us, any application in our daily life and understand the background, technology, and limitations of the industry; (2) invite field experts to engage in exchange and problem clarification. This step helps users quickly grasp relevant technology features to aid in the subsequent market research, interviews, and idea generation.

Step 2 Observe: Compile the data obtained in Step 1, and conduct actual market research to look for other usable products and technologies and understand whether products associated with said technologies already exist on the market. Then, use methods such as interviews to understand and divulge customer (market) needs, which help the users in defining the design problems and customer needs from the perspective of user-centered design.

Step 3 Point of view: Integrate and analyze the data from the two previous steps, and define customer needs and the design problems. Step 4 Ideate

4-1 Brainstorming and classification: Brainstorm on the market products, technologies, background knowledge, and usable products derived in the first three steps and give brief explanations on post-it notes. Categorize and number them as the elements of the first layer in the 9-window method. This step helps users focus and fulfill the usable technologies or products that meet the needs of the technologies in the field during the concept divergence process.

4-2 9-window method: This step helps users break cognitive inertia to develop creative concept combinations and find creative design concepts from within these combinations. During this step, the users place the design subject in the center of the 9-window chart and put the categories derived in Step 4-1 in the boxes of the first layer of elements. The elements of the first layer are then placed in the boxes of the second layer for divergence. During the process, brief descriptions should be made intuitively until the form is completed, regardless of whether they are correct. The users can define any number of divergence layers. If there are fewer than eight categories, then other elements are used to fill out the boxes before divergence. Finally, the convergence of the 9-window chart starts from the outmost layer toward the center. Aside from the central subject of each layer, two other elements must be selected for idea combination generation. The written format of idea combinations is “Subject = Element 1 + Element 2 + Element 3 + ... + Element x.” This step helps users generate more creative solutions during ideation. The 9-window chart is showed in Figure 2.

4-3 Idea sketching: This part involves sketching the idea combinations obtained in Step 4-2 using C-sketch and writing down the idea combination and code on the top of the paper. This reveals the context that can be followed during the ideation process and also facilitates the later induction and organization. The number of C-sketch exchanges is based on the number of team members (for example, if there are three team members, then three exchanges are made). In this step, a three-round C-sketch is performed: (1) after the first round, a group discussion is conducted to select and propose the optimal concept, which is then discussed with experts to clarify the technical limitations and the feasibility of the concept; (2) based on the feedback derived in the first round, the optimal concept is subjected to the second round of design concept optimization followed by expert discussion; (3) further design concept optimization is then performed based on the expert feedback from the second round. This step helps

users generate technologically feasible design concepts that meet customer needs. Visualizing the design concepts can facilitate group discussion and the later definition of concept functions.

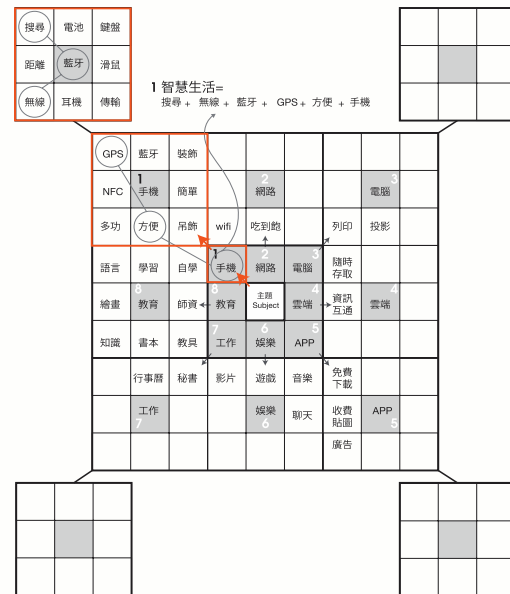

Fig. 2 9-window chart

4-4 AEIOU and 5W1H: Based on the optimal concept selected in the first round of c-sketch in Step 4-3, the usage environment, components, functions, mechanisms, and target customers of the design concept are then defined using AEIOU (activity, environment, interface, object, user), which helps the users define target customers and products (services). The usage environment, functions, and usage methods of the product are then examined using 5W1H (who, where, what, when, why, how), which helps clarify the requirements of the design concept so that the design is more detailed and complete and so that the user can construct the later personas and scenarios. The 9-window chart with AEIOU & 5W1H is showed in Figure 3.

4-5 Scenario building and storytelling: This part involves writing the persona of the target customers obtained in Step 4-4 and giving brief but specific descriptions of their basic characteristics (name, gender, occupation, education, hobby and personality). With who, where, what and when as the focus, the procedure framework of the scenario is written down, and a brief description of the problems that customers may encounter in specific situations when they use the product (service). The scenario framework is then refined using text or images, which assists users in discussing and

exploring scenario problems for design concept optimization and prototype construction. Chart for scenario building and storytelling are showed in Figure 4.

9 Windows Technique - Converge Strategy
九宮格法-收斂式 AEIOU、5W1H

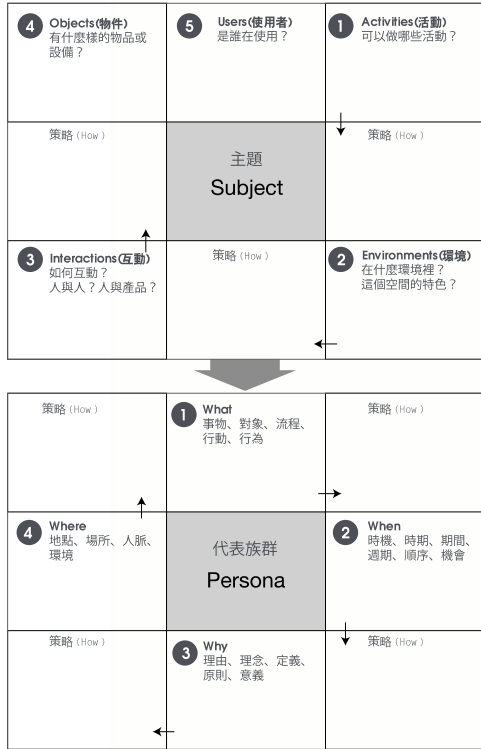

Fig. 3 9-window chart with AEIOU & 5W1H

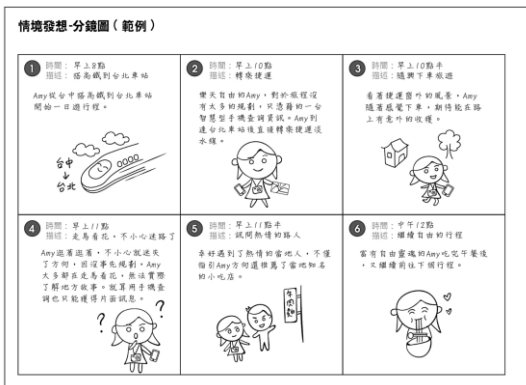
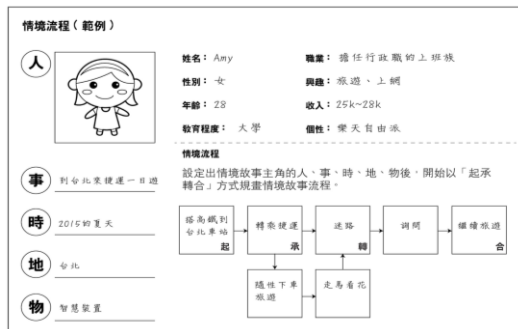

Fig. 4 Charts for scenario building and storytelling

Step 5 Prototype: This step integrates the results of the previous steps for design concept optimization and model construction, which assists design teams in determining whether the design meets the needs of target customers during the construction process and whether any revisions and improvements are needed during the usage process. This step is executed three times: (1) using sketches to visualize the concepts, (2) using sketches and 1:1 rapid-prototypes to help the users determine whether concept needs any improvements in aspects such as size, function, or mechanism, and finally, (3) using sketches, 1:1 models, rendering of the product, package designs, and relevant introductions (such as usage processes) to fully present the design concepts.

Step 6 Test: This step uses concept tests for both experts and target customers to help make the design concepts more focused and confirm whether the concepts meet market and user needs and whether they can be used effectively. This step requires three rounds of tests: (1) the first proposal and expert discussion are conducted with the optimal concepts obtained in the first round of Step 4-3, which helps the users in understanding the pros and cons, feasibility, and marketability of the design concepts; (2) based on the expert feedback derived in the first round, a second round of design concept optimization is performed using c-sketch, followed by discussion where one optimal design concept is chosen for the 1:1 rapid-prototype, and the second proposal and expert discussion are conducted; (3) finally, based on the expert feedback derived in the second round, 1:1 models, rendering of the products, package designs, and relevant introductions are made for proposal. This helps the users in creating design concepts that are technologically feasible and meet target customer (market) needs from a user-centered perspective.

4. A Case Study on EGF Application

The study was performed during the Industrial Design course of the first semester of the 2016-2017 academic year and lasted a total of ten weeks. The design topic was epidermal growth factors (EGF), which was provided by the client (a biochemistry expert). The goal was to apply the client's EGF production to generate innovative EGF products in commercial markets. There were 12 graduate students (divided into four groups), 1 design expert, and 1 biochemistry expert, participating in this study. The Design Thinking based Product Design process was proposed and chosen for this study. The results were as follows.

Step 1 Understand: After the design topic is defined, this step helped the participants quickly understand the industry and correctly define the design problems and develop the design concepts. This step was divided into two phases. The participants first gained an understanding of the EGF background, technology, and current market by collecting information on their own. Interviews with the expert (in this phase, the interviewee was the biochemistry expert, who was also the client) helped them understand new and conventional manufacturing processes, the types of wounds EGF can be applied to, costs, required sales, methods of preservation, shelf life, and its advantages.

Step 2 Observe: In this step, the participants performed actual market research and interviews based on the information they obtained in the previous step to divulge customer needs and usable technology and products, which helped them define the design problems from the perspective of the target customers. After compiling the information, they discovered that currently EGF technology is mainly used in beauty care and wound care; EGF can accelerate healing and improve skin condition. Based on these results, the participants then conducted actual market research and interviews in corporate channels associated with cosmetics.

Step 3 Point of View: After compiling and analyzing the results of the information searches, expert interviews, and actual market research, the participants defined the design problems and customer needs. In this case study, the design problems were defined as follows: (1) how do customers accelerate healing and reduce discomfort after micro-cosmetic surgery? (2) How can bacteria growth be reduced in beauty care products? (3) No beauty care product combining beauty bars and skin care products exists on the market yet.

Step 4 Ideate

4-1 Brainstorming and classification: The participants then brainstormed regarding the current products, possibly usable products, and technologies derived in the three previous steps, briefly described them on post-its, and then categorized them as the first layer of elements in the 9-window method. In this case study, the participants produced a total of 31 elements and divided them into four categories: skin care products, skin care tools, beauty care, and getting rid of the old to make way for the new (details in Fig. 5).

4-2 9-window method: Using the 9-window method, the participants diverged and converged the information obtained in the three previous steps to generate idea combinations in hopes of producing creative design concepts. With EGF as the central focus, the number of categories obtained in the first layer in

Step 4-1 was less than eight, so four other elements associated with EGF technology were added (cosmetics, healthcare, trauma, and regeneration) to fill in the first layer of boxes in the 9-window method. The first layer of elements was then placed in the second layer for divergence, which was then followed by convergence. This case study produced a total of 9 idea combinations (details in Table 1).

| Skin Care Products | | Skin Care Tools | Beauty Care | Getting rid of the old to make way for the new |
|--------------------|--------------|-----------------|-------------------------|--|
| Hand Mask | 晚安紙 | Shower Ball | Nail Polish | Face Washing Machine |
| Lip Mask | Toner | Wet wipe | Bath Lotion | Shaver |
| Mask | Finger Stall | Tissue | Dark Spot Corrector Pen | Deep Cleaning Pore Strips |
| Foot Mask | Lotion | Beauty Bar | Make-up Pad | Blackhead Remover Gel |
| Eye Mask | Capsule | Make-up cotton | Lipstick | Razor |
| Eye Cover | | Ball | | Hard Skin Remover |
| Lip Balm | | | | File a Foot |
| | | | | Pimple Clips |

Fig. 5 The detail of brainstorming and classification

4-3 Idea sketching: The participants sketched and coded the idea combinations obtained in Step 4-2 to facilitate discussion and organization. Six of the idea combinations were chosen for brainstorming using C-sketch and divided into two major groups, ABC and EFG, before brainstorming and sketch coding (Table 2). During C-sketch, the six idea combinations A, B, C, E, F, and G were exchanged three times. In the end, a total of 18 design concepts were produced.

The design concept C-A-B developed from idea combination C was chosen for sketch optimization. For the sake of portability, the original can design was changed to a pen design and combined with a facial massage tool. The optimized sketch was then numbered as C-A-B-1. Another C-sketch was performed, and the final number chosen was C-A-B-1-c-b-a (Table 3) for the first proposal and expert discussion. Discussion revealed that the problems with the design included cleaning after use, discharge of EGF ball waste, fixing the balls in place, the means of ensuring that the EGF balls will burst, and finally, whether bursting and spraying will be better than bursting alone. The design was optimized based on the first expert feedback to determine whether any functions or components needed to be added or removed. After discussion, the original design was changed to a detachable design; after use, washing the massage head would clean off the EGF ball waste. Wall tubes stabilized the tubes, slide

rails controlled the dispensation of the balls, and bursting them used the EGF balls. The resulting optimized sketch code was C-A-B-1-c-b-a, which was used in the second proposal and expert discussion (details in Table 3). Discussion of the mechanisms and ease of use prompted the slide rail design to be changed to a turntable. Refills were made using a soft silicon tube. The final design sketches are as shown in Fig. 8.

Table 1 Idea Combinations and Coding



| No. | Idea Combinations | Code |
|-----|---|------|
| 1 | Brow growing + Makeup + Brow pencil + Pigmented adhesive crayon + Body painting + 3D Printing | / |
| 2 | Beauty tools + Hair dye + Facial massage + Ion (skin) cleansing + Hole + Psychologist | / |
| 3 | Regeneration + AI + Human cloning + Earthworm + Soil + Tail Regeneration | E |
| 4 | Getting rid of the old to make way for the new + Teeth whitening + Blue light + Alpha-hydroxy acid + Albinus' muscle + Face-blotting papers | C |
| 5 | Joint surgery + Shavers + Cover + Wound + Spring + Airbag | A |
| 6 | Regeneration + Beauty + Hydrogen Peroxide Solution + Sticker + Tattoo + Deform | G |
| 7 | Medical + Makeup + Band-aid + Needle + Tourniquet + Drip + Rocket launcher | B |
| 8 | Skin care + Sleeping pack + Laser + Mole removal + Spot corrector + Pen | F |
| 9 | Makeup + Lipstick + Concealer + Orthodontics + Mydriatic + Eye contact | / |

Table 2 C-sketch code sequences and categories

| Group | Member | Sketch sequences and code numbers | | | | | |
|-------|----------|-----------------------------------|-----|-------|-----------|---------------|---------------|
| ABC | Member A | A | A-B | A-B-C | A-B-C-1-a | A-B-C-1-a-b-c | A-B-C-1-a-b-c |
| | Member B | B | B-C | B-C-A | B-C-A-1-b | B-C-A-1-b-c | B-C-A-1-b-c-a |
| | Member C | C | C-A | C-A-B | C-A-B-1-c | C-A-B-1-c-b | C-A-B-1-c-b-a |
| EGF | Member E | E | E-G | E-G-F | E-G-F-1-e | E-G-F-1-e-g | E-G-F-1-e-g-f |
| | Member G | G | G-F | G-F-E | G-F-E-1-g | G-F-E-1-g-f | G-F-E-1-g-f-e |
| | Member F | F | F-E | F-E-G | F-E-G-1-f | F-E-G-1-f-e | F-E-G-1-f-e-g |

4-4 AEIOU and 5W1H: The participants used AEIOU to define the usage environment, function, components, and target customers of the design concept and then re-examined the product functions, usage method, and necessity of the concept using 5W1H. In this case study, people who pay attention to their appearance were set as the target customers. The movable mechanism design enables facial care at home, outdoors, or during travel at any time. The small size of the product makes it easy to customers to carry it with them, and the EGF balls are dispensed at fixed quantities to reduce wastefulness and bacteria growth. Finally, using steel balls can increase the absorption rate of the beauty care product (details in Fig. 6).

Table 3 Sketches of concept development in Group C

| Sketch |  |  |  |
|--------|---|--|--|
| Codes | C-A-B-1-c | C-A-B-1-c-b-a | C-A-B-1-c-b-a concept optimization |

| | | |
|---|--|---|
| How Can carry everywhere | What Beauty care | How EGF Beauty care balls |
| Where Everywhere | The person who care their face | When Go out, travel, at home |
| How Increase the speed of absorb by massage | Why Increase the effect of facial care | How When we doing the facial care |

| | | |
|--|--|----------------------------------|
| Object Two step turntable, valve, ball | Users The person who care their face | Activities Facial care |
| How Manual control | EGF Getting rid of the old to make way for the new + Teeth whitening + Blue light + Alpha-hydroxy acid + <i>biogus</i> muscle + Face-blotting papers | How Massagers |
| Interactions Movable mechanism | How Go out, travel, at home | Environment Everywhere |

Fig. 6 AEIOU and 5W1H

4-5 Scenario building and story telling: After using AEIOU and 5W1H to define the products and the target customers, scenario-based designs and personas assisted the participants in creating user-centered optimized design concepts and exploring scenario problems. In this case study, people who pay attention to their appearance were set as the target customers. To refine character features, the scenario process framework was based on the following: On Sunday after work (when), Joanna (who) goes home (where) to use her EGF face massager (what) to perform her daily facial care (why). The process framework was then further refined to divulge the scenario problems. In this stage, the participants did not find any scenario problems (Fig. 7).

| | | |
|---|------------------------|---|
|  | Name : Joanna | Education : Master |
| | Gender : Female | Occupation : Ad Planning Specialist |
| | Age : 28 | Hobby : Travel, reading, photography |

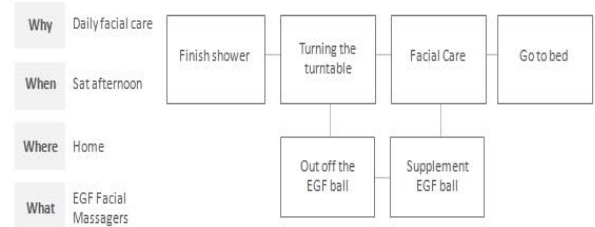

| Time 21:50 | Time 22:30 | Time 22:32 |
|--|--|--|
| Joanna just got home. At next day she need to attend a wedding so she go to take a shower . | After the shower, she is going to do the daily beauty care. She take the EGF facial massagers and turn the turntable. But she notice she is out off the EGF balls . | Joanna open the refill bag and fill the balls into the EGF facial massagers. Then turn the turntable to racking the EGF balls . |
| Time 22:33 | Time 22:40 | |
| Joanna use the massage balls of the EGF facial massagers to massage her face. | Go to sleep after finish the daily beauty care. | |

Fig. 7 Persona and scenarios

Step 5 Prototype: Following the compilation of the information from the various stages and design concept optimization was model construction, which helped the design team in re-examining whether the design met their needs and whether any revisions or improvements were necessary. The final concept designs produced by this case study are as shown in Figs. 8 and 9.

Step 6 Test: This step helped to confirm whether the design concepts meet technological limitations, market needs, and the needs of the target users. This step includes two concept proposals, two expert discussions, and one achievement proposal. Two experts served as advisors during the process, an industrial design expert and a biochemistry expert.

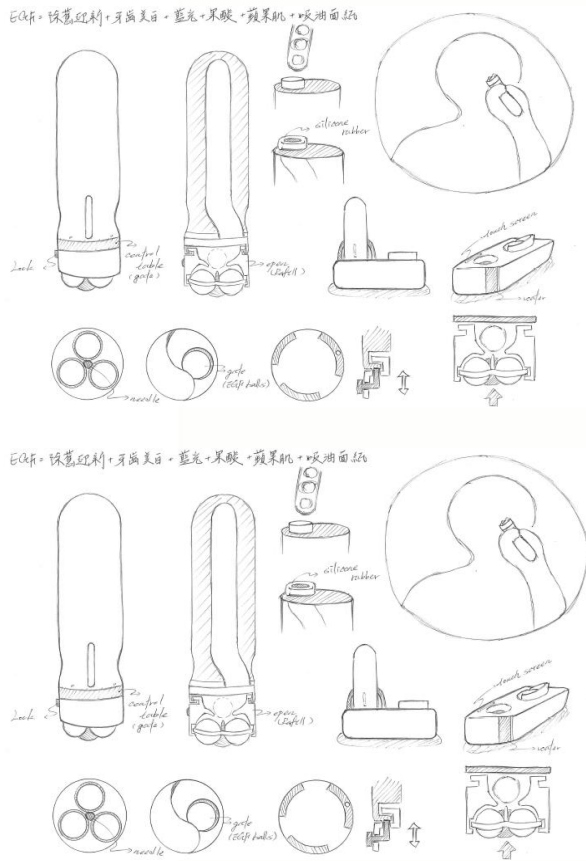

Fig. 8 The final design sketch



Fig. 9 EGF massager

5. Conclusion

This study employed the six steps of design thinking proposed by Carroll et al. (2010) as the research framework and added appropriate innovation tools to develop a structured design thinking process. Understand and observe help users quickly grasp background knowledge and divulge user (market) needs to clarify customer needs and design problems (point of view). Subsequently, the 9-window method is

used to break cognitive inertia for the development of design concepts, and sketches are made. The concepts are designed using AEIOU and 5W1H, following which character features and scenario problems are described using scenario-based designs to divulge scenario problems (ideate). Finally, testing is performed using the prototypes, which helps the users create design solutions that accept technological limitations and fulfill user (market) needs. With the integration of design thinking and innovative thinking tools, users have steps to follow and tools to use. In addition, the preliminary procedures of the structured design thinking process can serve as reference for designers and assist designers and developers in brainstorming design concepts systematically. The design concepts proposed in this study serve as the initial stages of the design concept stage for product development. Limited by time and space, we did not include the actual user data and did not consider the costs, manufacturing factors, or feasibility of the design concepts. We will continue in this direction in later research.

6. Acknowledgements

We thank the Ministry of Science and Technology, Taiwan for funding this project, project no. MOST 105-2221-E-131-024- and MOST106-2221-E-131-017-. We also thank the anonymous reviewers for their valuable suggestions, which improved this study. Finally, we thank Professor Liang-jung Chien, Shih-chen Lai, and Zi-han Li for their participation and efforts, which made this study progress more smoothly.

7. References

Brown, T. (2008). Design Thinking, *Harvard Business Review*, 84–92.

Brown, T. (2010). *Change by Design: How Design Thinking Transforms Organizations and Inspires Innovation*, Harper Collins.

Brown, T. & Wyatt, J. (2010). Design Thinking for Social Innovation, *Development Outreach*, 12(1), 29-31.

Carroll, M., Goldman, S., Britos, L., Koh, J., Royalty, A. and Hornstein, M. (2010). Destination, imagination & The Fires Within: Design Thinking in a Middle School Classroom, *International Journal of Art & Design Education*, 29(1), 2-85.

Chen, L.A. (2005). Creative Thinking Strategies & Skills. *Bulletin of Educational Resources and Research*, 30, 201-265.

Guest, D. (1991). The Hunt is on for the Renaissance Man of Computing, *The Independent*.

- Hansen, M.T. (2010). IDEO CEO Tim Brown: T-Shaped Stars: The Backbone of IDEO's Collaborative Culture, *Chief Executive*.
- Hasso Plattner Institute of Design at Stanford (2007). Design Thinking Process, C.A.: Stanford University.
- Imaizumi H. (1999). *Introduction to memology: innovative thinking tools/basis applications*, 1st ed., Yuan-Liou Publishing.
- Kulkarni, S., Summers, J. D., Vargas-Hernandez, N. and Shah, J. J. (2001). Evaluation of Collaborative Sketching (C-Sketch) as an Idea Generation Technique for Engineering Design. *Journal of Creative Behavior*, 35(3), 168-198.
- Leonard-Barton, D. (1998). *Wellsprings of Knowledge: Building and Sustaining the Sources of Innovation*, Harvard Business School Press.
- Li, J. L. (2009). *Whole brain learning: how to pass every test*, 1st ed., Third Nature Publishing.
- Lin, J.R. (2006). *Effect of Mandala Cerebration for Individual Creativity Brainstorming: A Case Study of Mandala Cerebration Application Curriculum at the Digital Education Institute of Information Industry*, Master thesis, Yuan Ze University, 2006.
- Linsey, J. S., Clauss, E. F., Kurtoglu, T., Murphy, J. T., Wood, K. L., & Markman, A. B. (2011). An experimental study of group idea generation techniques: understanding the roles of idea representation and viewing methods. *Journal of Mechanical Design*, 133(3).
- Linsey, J. S., Green, M. G., Murphy, J. T., Wood, K. L., & Markman, A. B. (2005). "Collaborating To Success": An Experimental Study of Group Idea Generation Techniques. In ASME 2005 International Design Engineering Technical Conferences and Computers and Information in Engineering Conference (pp. 277-290). American Society of Mechanical Engineers.
- Shah, J., (1993). "Method 5-1-4 G – A variation on method 635", MAE 540 Class Notes, Arizona State University, Tempe, AZ.
- Thomsen, D. (2013). Why Human-Centered Design Matters, [Online forum comment]. Retrieved from: <https://www.wired.com/isights/2013/12/human-centered-design-matters/>

AUTHOR BIOGRAPHIES

Chun-Ming Yang is an Assistant Professor in Department of Industrial Design, Ming Chi University of Technology, Taiwan, ROC, previously a Design Center Manager at Ford Motor (Taiwan). He completed his Ph.D. in the Industrial Engineering at the University of Rhode Island, USA in 2005; both M.S. and B.S. (graduating Cum Laude) degrees in the Mechanical Engineering from the University of Missouri-Rolla, USA in 1996 and 1994, respectively. His teaching and research interests include Design Thinking, TRIZ, Bio-inspired Product Design, Universal Design and Design for the Environment.

Thu-Hua Liu is the President at Ming Chi University of Technology and a full Professor in Department of Industrial Design, Ming Chi University of Technology, Taiwan, R.O.C. He received a Doctoral Degree in the Industrial Engineering and Management at the University of Iowa, USA in 1989 and a Master Degree in the Mechanical Engineering at Stevens Institute of Technology, USA in 1983. His teaching and research interests include STEP-ISO 10303, System Engineering and Design, PDM and CALS, and Design for Welfare.

Ya-Yi Zheng is a Graduate Student in Department of Industrial Design, Ming Chi University of Technology, Taiwan, R.O.C. Ya-Yi holds a Bachelor degree in Department of Business and Management from Ming Chi University of Technology. Her areas of interests include Design Thinking, Business and Management.

Review of Systematic Software Innovation Using TRIZ

Usharani Hareesh Govindarajan^{1*}, D. Daniel Sheu¹, Darrell Mann²

¹National Tsing Hua University, ²IFR consulting

*Corresponding author, e-mail: hareesh.pillai@ie.nthu.edu.tw

(Received 1 March 2016; final version received 20 March 2019)

Abstract

This paper attempts to review the use of TRIZ, Theory of Inventive Problem Solving, in the field of software innovation. TRIZ finds widespread applications in many fields of engineering such as mechanical, electrical, electronics, chemical, materials, industrial engineering, etc. Even, TRIZ has its applications in management and strategies. However, the applications of TRIZ in the field of software engineering to solve problems that arise during phases such as software design, development, coding, testing, and maintenance seems to be in its very initial phase. The primary objectives of this paper are to review and consolidate the current state of the art in the area of TRIZ for software related problems by a literature review. The current review will help academicians and industry experts to understand the current state and to visualize a possible future direction.

Keywords: Software TRIZ, Systematic Software Innovation, TRIZification of software, Software TRIZ review.

1. Introduction

Innovation can be viewed as an invention that has been successfully translated into commercial success. An invention is an event that helps in finding a better way of doing things. Inventive thinking or, more generally, ‘creativity’, has traditionally been viewed as a random occurrence that occurred anywhere from office brainstorming sessions to coffee breaks to morning showers -- an ‘anywhere anytime phenomenon’. It was also assumed that the occurrence of such ‘thinking outbursts’ was untraceable and almost impossible to replicate within a given timeframe. If ‘invention’ is about the generation of ‘ideas’, innovation is about the conversion of those ideas into commercialization. It is well-known that at the present time, 98% of all innovation attempts are ended in failure (Mann, 2012). Within the world of Information Technology, the failure rate is currently slightly worse, running at a failure rate of 98.5%.

1.1 Systematic Innovation Background

Systematic Innovation (SI) is a field which concerns about developing or using systematic methods/processes to generate innovative ideas for Technical, Strategic, or

Business aspects of Opportunity Identification and/or Problem Solving. (Sheu, 2015). Figure 1 shows a proposed classification of Innovation Methods (IM) in which SI is a major part of it. (Sheu, 2015). (Sheu and Lee 2010). TRIZ is the Russian acronym for “Theory of Inventive Problem Solving” and is a branch of systematic innovation with ample support levels available in the form of community, training, publications and enthusiasts. TRIZ has circulated around the world fairly successfully in more than 50 countries as indicated by (Bradford, 2016.) The TRIZ philosophy and applications have been expanded into various usage fields such as the ones shown in Figure 2. (Sheu, 2015). (Sheu and Lee, 2010). Table 1 shows the typical extended application areas of Modern TRIZ (SI). This paper focuses on the review of systematic software innovation using TRIZ. This is a very new area having relative much less developments compared to other application areas however with great potential for further developments.

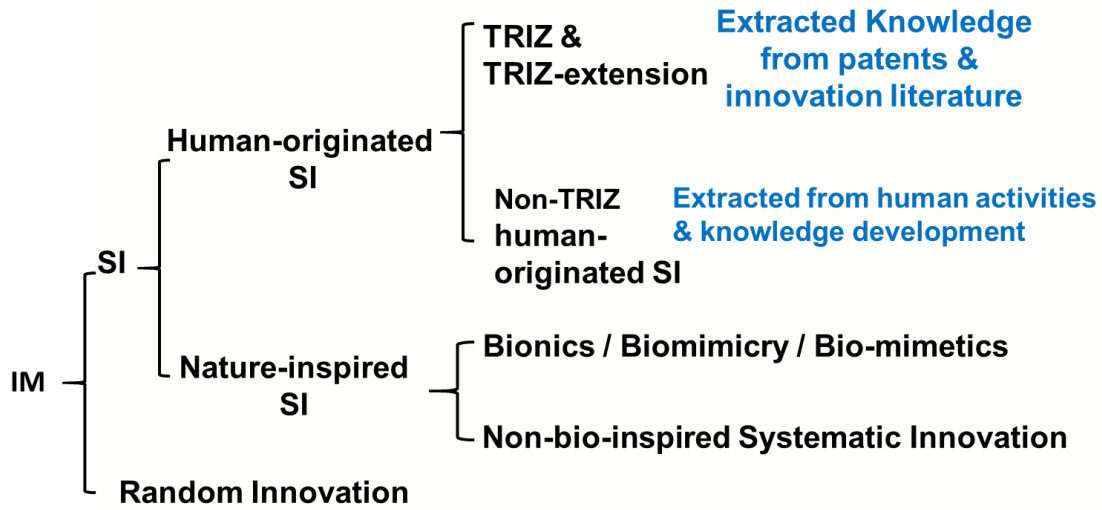

Fig. 1 A proposed classification of Innovation Methods

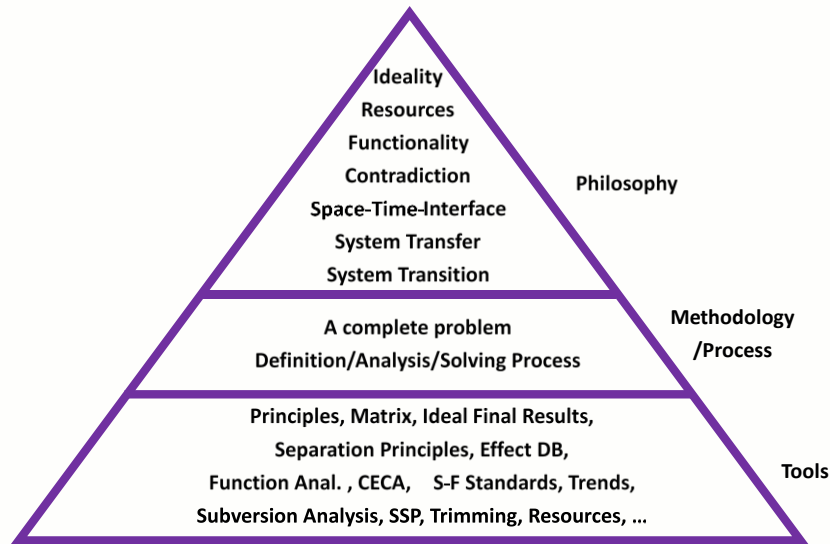

Fig. 2 Hierarchical View of TRIZ (Mann, D. L. 2009, Sheu, D. D. 2015)

Table 1 Extended Application Areas of Modern TRIZ (SI)

| |
|---|
| <ul style="list-style-type: none"> ■ Identifying Innovative Products & Services ■ Solving Engineering problems <ul style="list-style-type: none"> ● New and existing product developments/improvements ● New and existing process/equipment developments/improvements ● Patent circumvention/regeneration/enhancements ● Software innovation ■ Management/Service Applications <ul style="list-style-type: none"> ● Establish Innovation Strategies/Business Model innovations ● Service innovation ● Identifying Organizational conflicts & solving them ■ Combine with other tools to solve problems: <ul style="list-style-type: none"> ● VE; QFD; FMEA; 6-Sigma tools, Lean, Kepner-Tregoe; ... |
|---|

2. TRIZ Philosophy

TRIZ is a philosophy, a set of systematic thinking methods, and a set of tools with software. Figure 2 shows a hierarchical view of TRIZ structure. At the base level, there are many tools for problem-solving. At the middle level, there is the methodology or process, which is a complete problem definition, analysis and solving process. In the process, it employs the various tools from the base level at appropriate stages of the process to define, analyze, and solve problems. Regardless at the tools level or methodology level, they are all based on some powerful philosophies known as Pillars of TRIZ. The traditional TRIZ has 4 philosophies which are Ideality, Resources, Functionality, and Contradiction. (Mann, 2007.) Identified Space/ Time/ Interface as the fifth pillar of TRIZ. (Sheu, 2015.) Identified System Transfer and System Transition as the sixth and seventh pillars of TRIZ. These are fundamental philosophies that make TRIZ powerful.

Figure 3 shows a conventional problem-solving approach in which experiences and trial and error are

used to take a specific problem into specific solution(s). A typical TRIZ Problem-solving Process is shown in Figure 4. Traditional problems solved by TRIZ are problems in technology and engineering context. Such problems require new, out of the box solutions unknown before (Souchkov, 2007-2014). TRIZ philosophy believes that in the center of most inventive problems lies a contradiction. A contradiction consists of a logical incompatibility between two or more propositions. TRIZ solves two types of contradictions. The technical contradictions which exist in the system prevent it from reaching a specific goal or achieving the desired solution and the physical contradictions occur when a parameter of the problematic system has incompatible needs to satisfy negative requirements, likely opposite requirements. The TRIZ method aims to eliminate contradictions in order to solve problems. Technical contradictions can be solved through 40 inventive principles, while physical contradictions can be solved through separation principles which include at least separation in space, time, system level, relationship, etc.

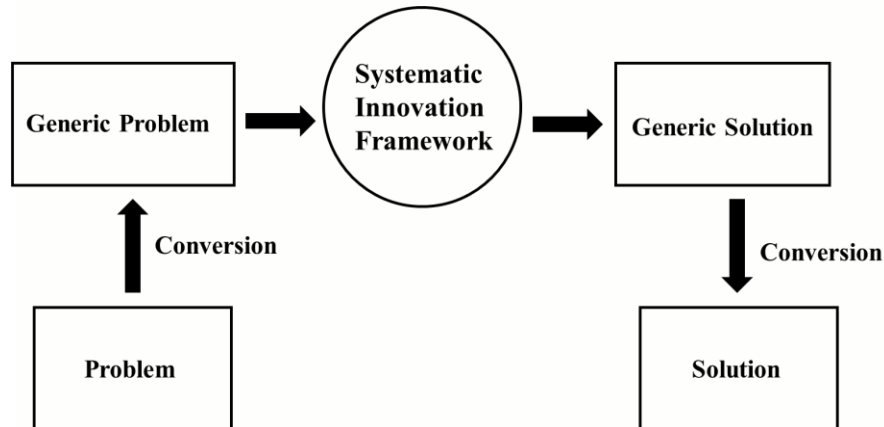
Fig. 3 Conventional Problem Solving Approach

Fig. 4 TRIZ Problem-solving Process

2.1 Some TRIZ tools relevant to software engineering

Innovation involves the deliberate application of information, imagination, and initiative in deriving greater or different values from resources, and includes all processes by which new ideas are generated and converted into useful products. Systematic innovation is the process of methodically analyzing and solving problems with a primary focus on identifying the correct problem to be solved and then generating innovative solution concepts Khomenko N. states that in order to be universal, tools and techniques should be as general as possible. However, general tools tend to bring general solutions. The ideas generated are sometimes so general that it might not be of any practical use. To summarize we need to customize generic tools to produce highly optimized results and to customize we need the theoretical background (Khomenko, 2010). This paper aims to build this theoretical background. The Classical (Russian) TRIZ methodology contains a host of tools. “A

review of TRIZ and its benefits and challenges in practice” published in *technovation* 2013 summarizes widely used tools (Ilevbare et al. 2013). In this section, an introduction to some tools that can be applied in software engineering is provided below (Toivonen, 2014).

1. 40 inventive principles - Inventive principles are generic problem solutions (contradiction elimination). They are compiled from mining patent databases and other sources of problems and their associated solutions. So far according to TRIZ terminology, there are 40 identified Inventive principles.
2. Contradiction matrix - A contradiction in the broadest sense is a problem to be solved. Contradictions are always between one or more parameters that need improvement against one or more parameters that are a hindrance and prevent the improvement. The contradiction matrix helps to reduce or eliminate such contradictions by point-

ing users to solutions which are known as inventive. Inventive principles are built on the analysis of technical systems patents. Moreover, the matrix is a statistical analysis of the use of these inventive principles in technical domains. Applying such statistical analysis in another domain helps to get a different perspective to cross-disciplinary problem solving. The general core concept is that while a problem may be unique to a given domain the abstract essence of the problem might have already been solved in another domain. Statistical analysis helps to understand this perspective thereby helping to solve problems.

3. Trends of evolution - TRIZ problem-solving visualizes evolution as a process that has a finite point (a point beyond which the need to evolve is not needed or not possible) Systems evolve with time through time and trends of evolution tools help collectively summarize the evolution patterns in various areas, suggest the evolution trend for a problem. By mapping system's current state regarding these trends it is possible to discover areas where there is a lot of potential for improvement.
4. Function and Attribute Analysis (FAA) -FAA is a technique to form an understanding of the current state of a system by mapping its elements and their interactions. FAA also helps to map both the positive and negative intangibles of a system.
5. Perception Mapping - Perception mapping is a method for approaching complex problems by mapping the network that the individual perceptions form and identifying which perceptions hold key positions in that network and focus improvement efforts on those areas.
6. Nine Windows Method (AKA system operator Method) - helps to look at the problem from different viewpoints regarding time (the past, present, future) and abstraction level (system, microsystem, macro system) It is flexible and can be used to understand a problem, discover resources and generate solutions.

7. Ideal Final Result -This tool allows the mapping of what perfect looks for different stakeholder groups regarding different attributes of the system (like speed, cost, etc.). The results are documented in the matrix where one dimension is formed by stakeholders and the other by system attributes. The matrix is useful for identifying contradictions. Ideality is given the below formula.

$$\text{Ideality} = \Sigma \text{Benefits} / \Sigma \text{Cost} + \Sigma \text{Harm}$$

8. Resource Tools -By mapping the available resources in a system it is possible to generate solution ideas that rely on free and/or underutilized resources. Resources can also act as a trigger for solutions. Resources can also be intangible like human cognitive biases.

2.2 Available TRIZ Software

There have been several attempts over the last 20 years to encapsulate TRIZ heuristics, tools, and protocols into software tools. This section is a review on generic TRIZ software's that have been pre-customized to solve software engineering problems. The first of these, 'TECHOPTIMIZER' from Invention Machine and 'Innovation 'WORKBENCH' from Ideation, were very much focused on the codification of TRIZ ideas from the world of engineering, and particularly the world of mechanical engineering. Other tools have subsequently been derived by a multitude of other players, such as GOLDFIRE by Invention Machine Corporation (subsequently sold to HIS Markit), PRO-INNOVATOR by IWIN company, IDEATION BENCHMARK by Ideation are examples of commercial software's available in this domain. etc. are commercial software's available in this domain. Other derivative software from TRIZ include 'PATENTINSPIRATION', which has sought to obscure much of the complexity of TRIZ behind smart solution search algorithm design. None of these providers have created any software specifically for the IT world. There are also a number of individual researchers or teams have developed some proprietary

software for various TRIZ tools. However, they are not dedicated for software innovation. So far, the only place where specific 'IT-TRIZ' software tools will be found are those offered by Systematic Inno-

3. Review of Systematic Innovation in Software Engineering

Information technology (IT) refers to all jobs that have to do with computing for all aspects of managing and processing information. IT involves ever-expanding areas of computing such as the internet, telecom equipment, engineering, healthcare, e-commerce, computer hardware, software, electronics, semiconductors, and computer services solving problems. IT problems are problems arising anywhere in the given above list. Troubleshooting is an example of IT problem. Troubleshooting is often applied to repair failed products or processes on a machine or a system. It is a logical, systematic search for the source of a problem in order to solve it and make the product or process operational again. Troubleshooting is needed to identify symptoms, determining the causes and solving it. Software reliability estimation is another area in computer science where TRIZ can be applied to increase flexibility, extensibility, and customizability. This section is a review of systematic publications in line with prior TRIZ application to solve software engineering problems (Domb, 2003). There have been several attempts to

vation Ltd, in the form of the MATRIX+ and EVPOT+ (Trends) tools, both of which contain specifically focused IT-industry problem types and solution databases

encapsulate TRIZ heuristics, tools, and protocols into software engineering for a few years now. (Kluender, 2011). (Ng, 2013). This section is a summarization of such attempts.

Figure 5 shows the events relevant to systematic software innovation. Systematic innovation saw its first publicly visible application in the field of software engineering in the year 1999 when Kevin C. Rea applied the technique to solve a concurrency problem. His observations were published in the TRIZ journal (Rea, 1999), (Rea, 2000), (Rea, 2002), (Rea, 2005d). Around then, many academicians, enthusiasts, and researchers have applied various TRIZ tools broadly in the field of Computer Science. This section is a review of many such prominent works. Even though many case studies of TRIZ applications to solve software engineering problems are not available for the public due to host company's non-disclosure policies, for clarity sake a timelines graph below list prominent published works (available in open forums and published in English language) in time order from year 1999 to year 2015 followed by a short summarization of the publications. Because of the language barrier, some Korean and Chinese publications are not included in the chart below.

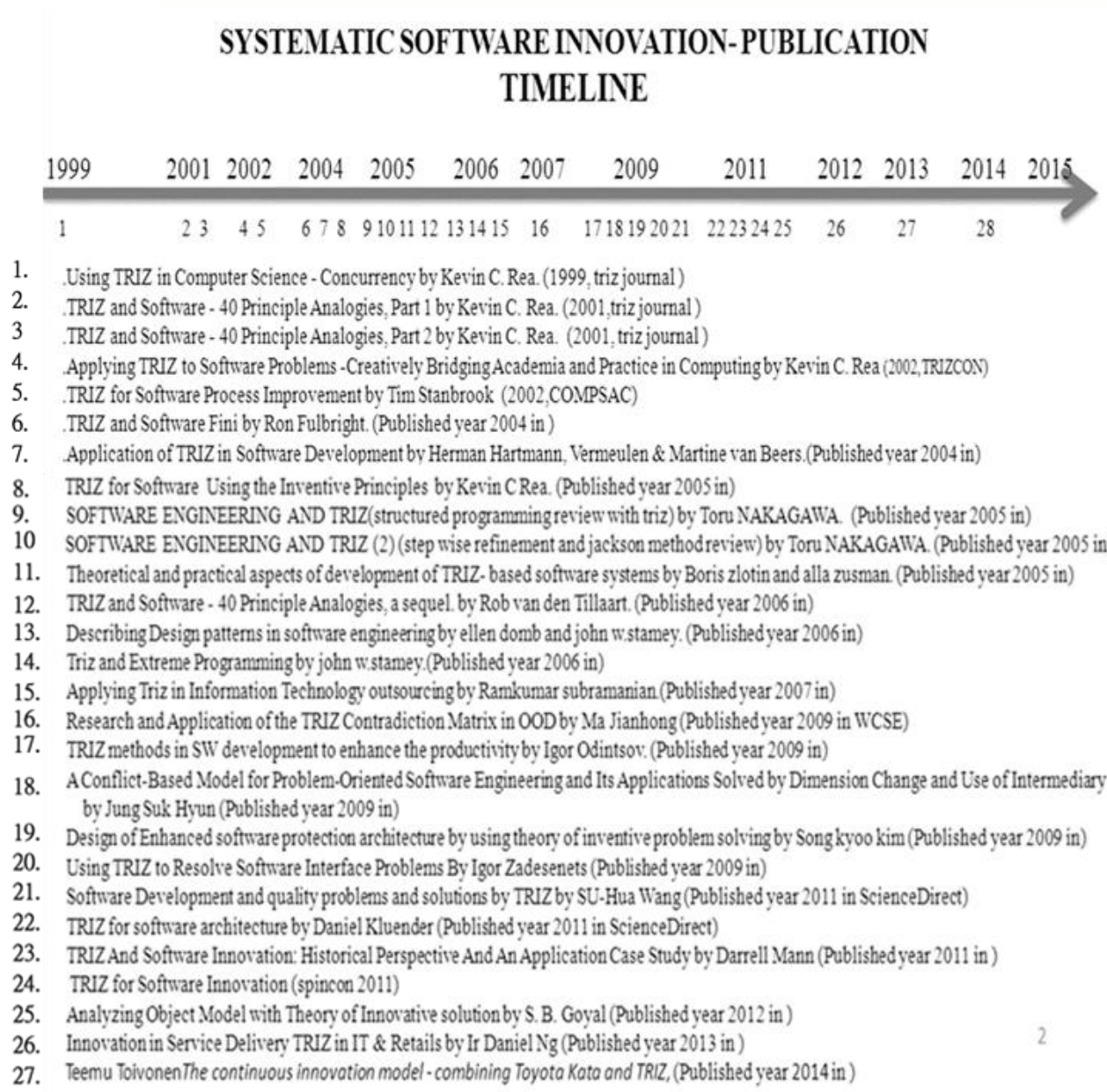

Fig. 5 Timeline of Papers Published

In the year 1999 Kevin C. Rea, a research scholar and consultant, attempted to break psychological inertia towards usage of TRIZ in the field of software engineering by demonstrating a solution to a software concurrency problem. He used the Su-field (substance field) analysis and the principles of contradiction in his demonstration which was published in the TRIZ Journal (Rea, 1999). The next year Rea published papers in 2 parts which were a conversion of the 40 engineering inventive principles in Information Technology or software context (Rea, 2000).

In 2002 Rea published a paper titled “Applying TRIZ to Software Problems” which gave an overview of various techniques that could be used in inventive software engineering. The paper also had given an example of implementing a multisport communications buffer using Su-field model. Thereby starting off a new area of applying TRIZ in software engineering, some experts also consider Rea’s work as the beginning of software TRIZification.

In the year 2004, Fulbright published a paper titled “TRIZ and Software Fini” which was an exten-

sion of Rea's work of 2001. The paper demonstrated software context of a few inventive principles whose equivalence was not given by Rea in his earlier work (Fulbright, 2004). The work was followed by Herman Hartmann, Vermeulen and Martine Van Beers. In their paper titled "Application of TRIZ in Software Development" supported the discussion on the subject how software engineering can also use TRIZ philosophy to solve problems. The publication focused on area's centric to software engineering such as Inventive Principles, Fast Algorithms, Moore's law, software size, architecture development and trends of technological evolution (Hartmann et al., 2015.)

Darrell Mann in the year 2004 through his article in TRIZ journal gave an introduction to the field of science with a comparative example of software versus a mechanical engine system. He also customized TRIZ pillars and contradiction matrix according to software requirements. The subject context of Darrell Mann was expanded in his book "Systematic Software Innovation" published in the year 2008 (Mann, 2008).

Kevin C. Rea in the year 2005 published the paper "TRIZ for Software Using the Inventive Principles" the objective of writing up was to showcase an example thereby breaking some amount of psychological inertia towards problem-solving using TRIZ. The contradictions that the example dealt with are "waste of time" against "accuracy of manufacturing" and the solution was stated via inventive principles numbered 24 mediator and 26 copying (Rea, 2005). Toru Nakagawa, a Japanese innovation scientist, in the year 2005 wrote a two-part paper (Nakagawa, 2005a.) (Nakagawa, 2005b). The first part titled "Software Engineering and TRIZ (structured programming review with TRIZ)" explains the concept of structured programming with center around a workaround for go-to statements used in programming constructs. "Go-to-less programming from the TRIZ perspective". TRIZ principles 1 (Segmentation), 6 (Universality), 7 (Nesting) were used for making the program easy to understand and advocated 'Structured Programming'. The second part titled "Software Engineering and TRIZ (2) (stepwise refinement and Jackson method review)" is a refinement of Jackson's method of structured programming in correlation with TRIZ along with some discussion on 'Prior-reading technique'. TRIZ principles like Segmentation, Local Quality, Intermediary, Prior Action, and Homogeneity have been used to make the comparison.

Boris Zlotin and Alla Zusman in the year 2005 published a paper, "Theoretical and practical aspects of the development of TRIZ- based software

systems," which in detail describes the need for TRIZ software and the people who needed to develop such systems with the requirement's and Consideration's need to make it keep in mind while building such systems (Zlotin and Zusman, 2005). TRIZ and Software - 40 Principle Analogies, a sequel published by Tillaart in the 2006 is an analogy of 40 inventive principles explained in a software context (Tillaart, 2006). The work is an updated analogy of Rea's work with some extra consolidations and value in the form of examples. A similarity study between Altshuller's 40 inventive principles and software design patterns by Erich Gamma, Richard Helm, Ralph Johnson and John Vlissides also known as "The gang of four" (Domb and Stamey, 2006).. The paper discusses time-space trade-off followed by a similarity study of design patterns with TRIZ such as adapter pattern with principle of mediator, bridge pattern with extraction principle, composite and iterator pattern with principle of universality, decorator pattern with the principle of nesting, flyweight pattern with the principle of transition to a new dimension and proxy pattern with the principle of parameter change

John W. Stamey published TRIZ and Extreme Programming (XP) which is an introduction to Waterfall model of software development with a comparative study of XP model to TRIZ Inventive Principles (Stamey, 2006). An Information Technology outsourcing analogy to 40 inventive principles under the paper titled "Applying TRIZ in Information Technology Outsourcing" by Ramkumar

Subramanian in the year 2007 has discussions on various laws in reference to inventive problem solving and its outsourcing equivalence (Subramanian, 2007).

"Research and Application of the TRIZ Contradiction Matrix in OOD" by Jianhong Ma published in the year for the field of object-oriented software design is proposed, paper further deals with the abstraction of parameters in object-oriented software design, construction of contradiction matrix, the application of the matrix and the establishment of design patterns. "TRIZ methods in software development to enhance the productivity" by Igor Odintsov published in the year 2009 shows TRIZ tool application in various Software Development Life Cycle stages (Odintsov, 2009). "A Conflict-based model for problem-oriented software Engineering and its applications solved by dimension change and use of intermediary" published by Jung Suk Hyun in the year 2009 deals with problem-oriented software engineering via an author specified problem-solving model named butterfly model (Hyun, 2009). The paper also solves a shopping cart problem using the proposed model.

"Design of enhanced software protection architecture by using the theory of inventive problem solving" published by Song-kyoo Kim in the year 2009 is on the stochastic software protection using closed queues with unreliable backup (Song, 2009). The paper performs stochastic multilayer software protection analysis and random backup module protection based on TRIZ contradiction principles 1, 10 and 11. "Using TRIZ to resolve software interface problems" published by Igor Zadesenets in year 2009 is a description to the problem-solving process using TRIZ (Zadesenets, 2009). The TRIZ models in the discussion here are the object-relationship model and the cause-effect model and how software problems can be solved using TRIZ methods. "Software Development and quality problems and solutions by TRIZ" published by Su-Hua Wang in the year 2011 is a description of quality problems in the field of software engineering and its solution using TRIZ (Wang, 2011). The paper discusses TRIZ fundamentals and tools followed by problems in software development followed by the applicability of TRIZ in software problems in broad scale.

"TRIZ for software architecture" (Mann, 2011) describes inventive principles and the contradiction matrix in a software context. The paper re-architected a flight simulator using TRIZ tools with similarity analysis of software quality attributes with technical parameters of a contradiction matrix and future scopes of these tools were proposed.

"TRIZ and Software Innovation" by Darrell Mann in the year 2011 gives a historical timeline style review of innovation in the field of computer science. The discussion is on 26 newly uncovered patterns for discontinuous software evolution which

3.1 Review Consolidation

The review which takes into account publications since 1999 shows the most explored areas in TRIZ for software suggests contradiction matrices and inventive principles as the most popular areas of

are placed under 3 groups namely physical, temporal and interfacial. The paper concludes with a case study of unmanned ariel vehicle control systems to enhance operational capability by using TRIZ contradiction matrix.

CRAFITTI consulting an innovation think tank distributed a comprehensive online presentation in the year 2011 titled "TRIZ for software innovation" which discusses various aspects of software innovation like patent analysis, elements of TRIZ contradiction, ideal final result development philosophy, and various trends laws of evolution and some advices on how to embed TRIZ into an enterprise. "Analyzing object models with theory of innovative solution" by S. B. Goyal published in the year 2012 gives a co-relation to Object Oriented Modeling Paradigm and TRIZ applicability in Object-Oriented Environment (Goyal, 2012). The paper gives an introduction to Object Orientation and Modeling technique UML (Unified Markup Language) and TRIZ. The paper concludes with a process of applying TRIZ to problem-solving in object-oriented modeling

A comprehensive presentation titled "Innovation in service delivery TRIZ in IT and retails" by Ir Daniel Ng available online from November 2013. The presentation starts with an introduction to TRIZ basic contradiction and the inventive principle is covered followed by few case studies. The presentation also contains various publication details in TRIZ and concludes with case sharing about internet mining and retail industry.

exploration as shown in Table 2. Detailed expansions of these attempts is in the earlier section..

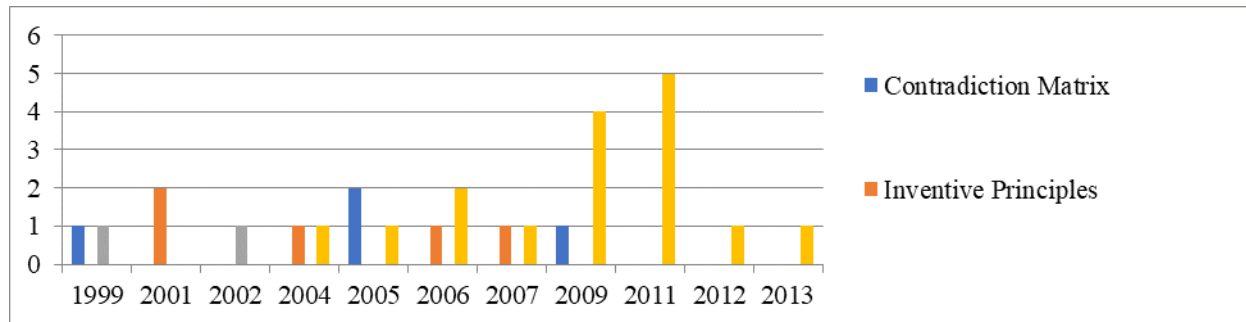
Table 2 Areas of TRIZ exploration in software context

3.2 Book Review

The time order of some relevant books regarding to systematic software innovation is shown in Figure 6.

SYSTEMATIC SOFTWARE INNOVATION- BOOKS TIMELINE

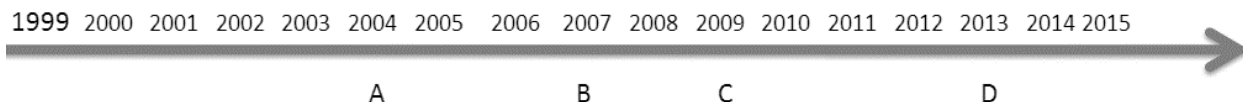

- A. Systematic Software innovation by Darrel Mann
- B. Triz principles for information technology by Umakant Mishra
- C. Improving Graphical User Interface Using TRIZ by Umakant Mishra
- D. Using TRIZ for Anti - Virus development Umakant Mishra

Fig. 6 Time Order of Books (Published in English Language)

Some contexts of the books are briefed below.

A. Systematic Software Innovation by Darrell L. Mann

Darrell Mann has integrated various TRIZ techniques and philosophy in this book which was re-written several times the final draft was published in 2004. The book is targeted towards the software engineering area and is a guide for professionals wanting to apply TRIZ in software engineering domain.

B. TRIZ Principles for Information Technology by Uma Kant Mishra

The books started as a manuscript presented in TRIZCON-2007. The response to the manuscript was overwhelming from around the world. The book summarizes how inventive principles can be used in IT domain by demonstrating patent analysis, case studies and pictorial examples against each principle of the invention. The book was also acclaimed highly by Toru Nakagawa of Japan and was translated in the Japanese language later.

C. Improving Graphical User Interface using TRIZ by Uma Kant Mishra (published in the year 2009)

The book is for GUI designers and TRIZ researchers. Graphical user interfaces have become critical to the interaction element in almost all products even though there is a great improvement in GUIs used a generation earlier there still are limitations. TRIZ principles like “Ideality”, “Functionality”, “Trends”, “Contradictions”, “Inventive Principles” etc. could be used to solve such problems. The book cites more than 100 inventions from US Patent Database and explains how the contradictions in the prior art methods have been overcome by applying very simple but innovative concepts.

D. Using TRIZ for Anti-Virus Development - Building Better Software through Continuous Innovation by Uma Kant Mishra.

"Using TRIZ for Anti-Virus Development" is a book by Uma Kant Mishra, on the application of TRIZ Techniques for improving the Anti-Virus technology. The book demonstrates how various techniques of TRIZ, including Contradictions, Inventive Principles,

Inventive Standards, Ideality, Su-Fields, Resources, and Trends of Evolution etc. are useful for taking the Anti-Virus technology forward to the next generation.

4. Current State

The preceding descriptions of activities and milestones concerning the convergence of TRIZ and ‘software’ suggests that the level of effort has been considerable. Even a cursory examination of the world of IT professionals, however, would rapidly reveal that the impact of this effort has been minimal. The large majority of IT professionals, in other words, will still have never heard of TRIZ. Refer to Figure 7 In terms of the Gartner Hype Cycle (Fenn et al. 2008), neither TRIZ nor its ‘Systematic Innovation’ successor would be perceived to have entered even the ‘technology trigger’ start point of the curve. This fact should provide some clues as to the likely future scope for TRIZ/SI activities in the software world. Before we enter that discussion, however, it is worthwhile to exploring some of the possible reasons why TRIZ/SI has not yet been viewed as a ‘Technology Trigger’ within the world of IT.

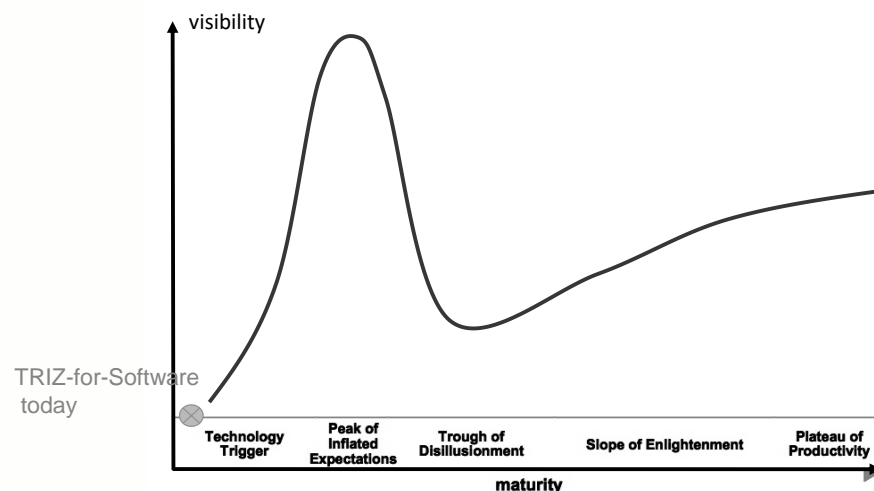

Fig. 7 Hype cycle and ‘TRIZ/SI for Software’ position

A review of the previously discussed TRIZ and software literature from Section 3 of this paper re-

veals two distinctly different approaches to the challenge of applying TRIZ to problems and challenges

within the IT world. The first of these approaches is to be found in nearly all of the texts discussed. It is an approach based on re-application of already established TRIZ tools, protocols, and procedures to IT problems. In theory there is nothing wrong with this strategy since a large part of the basic premise of TRIZ is ‘someone, somewhere already solved your problem’ and so an analogous problem in the world of, say, mechanical engineering, should according to the theory provide solution clues to a person working in the IT sector. In the case of truly universal findings like the 40 Inventive Principles this ‘analogous worlds’ assumption has proved to be valid. An extensive investigation by multiple authors has failed to reveal a ‘41st Principle’ that is found in the world of software that is not found in any other sector (Tillaart, 2006).

Beyond this finding, however, the relevance of the analogical approach has been found to be extremely limited. Attempts to apply the classic Altshuller’s Contradiction Matrix – a tool created in 1973 by the software industry even existed – is virtually meaningless since the 39 parameters that make up the sides of the Matrix bear little, if any, resemblance to parameters that a software engineer would consider to be relevant. Similar disconnects can be observed with attempts to deploy the TRIZ S-Fields and Inventive Standards tools: the level of abstraction required for software engineers to meaningfully use the tools is significant. Considerable enough at least that were a software engineer new to TRIZ to accidentally read one of the papers or articles on the subject their likely reaction would be either, a) this has absolutely nothing to do with me, or, probably more likely, b) the solution being proposed in this case study is a really bad solution to the problem and so the method through which the solution was derived must therefore also be bad. Which is a way of saying that there are few, if any, published papers that contain anything that a software engineer would think to be a ‘good solution’? Not to mention the fact that in the large majority of published cases, the mediocre result was not derived by actually using TRIZ in the first place.

When Mann and the Systematic Innovation Company entered the world of software through the eventual publication of the Systematic (Software) Innovation book, it was the result of an extensive research, commenced in 1999, to go back to the original TRIZ philosophy and to actually analyze hundreds of thousands of breakthrough software solutions. Three big things emerged from this decade-long and still going research:

- a) The large majority of the classical TRIZ tools were meaningless in the context of software problems. Making an analogous connection between a parameter in the 39x39 Altshuller Contradiction Matrix and a software problem might generate some Inventive Principle solution suggestions, but these suggestions would be largely irrelevant to the specific problem at hand. (Mann, D. L. 2008) reports an average relevance of less than 20%. If the TRIZ tools were to ever become relevant to software engineers, new research and new tools would need to be created.
- b) Working with actual software engineers and examining the sorts of problems they encounter during their work it very quickly became clear that their biggest problem was *not knowing what the problem was*. The roots of this problem come from the prevailing software industry challenge of the gap between the software architects and coders and their system ‘customers’. The customers tending to not know what’s possible, and the coders not knowing what their output is actually going to be used for. A big part of this gap may be seen to involve the ‘unspoken’ – lack of tacit knowledge and lack of understanding of the emotional drivers that affect peoples’ behavior.
- c) Also through the experience of working with software engineers, whenever they do encounter a problem it is very rarely what might be classified as a ‘software problem’. Far more likely was that the problem was a management problem or a problem with the supporting technical systems which the software was expected to control. Once a solution could be configured, it could almost

always be coded. The need for solving ‘coding’ problems was and still is very much the exception

As a consequence of these findings, the architecture of the Systematic Software Innovation book changed considerably compared to other TRIZ tomes (section 3.2, Book A). Firstly it compiled together all of our research findings to build software-bespoke new tools. Second, and more importantly, it introduced and associated software tools, it has made a very little impact beyond a small number of IT service organizations. Perhaps not surprisingly this disappointing outcome has provoked a significant additional program of research to reveal the underlying reasons for this lack of recognition by the software community on TRIZ and the new suite of Systematic Innovation tools.

One thing for sure is that there is no shortage of innovation attempts taking place in the IT world. Figure 8 shows another version of the Hype Cycle, this time showing the relative positions of some of those attempts along the cycle. To the best of the authors’ knowledge, none of these attempts has made any use of TRIZ/SI. They are all innovation attempts borne of a perceived customer need followed by trial-and-error solution finding. Given the choice of deploying a repeatable innovation process (e.g. TRIZ) or using trial-and-error, most industries would tend to opt for the more efficient approach. So, paradoxically,

rather than the rule.

duced new tools and approaches from outside TRIZ that would better assist software engineers in understanding their real customer needs rather than the ones contained in the specifications they published.

Despite all of the time and effort that went into the production of the Systematic Software Innovation the IT world – which is one of the most innovative on the planet right now – is the one showing the least inclination to using more efficient processes. Why might this be?

One very logical answer to the question might be that trial and error works in the virtual world because it is possible to make very rapid solution iterations at negligible cost when compared to what needs to occur to make a solution iteration in the physical world.

Another one is that ideas spread much faster in the virtual world. No sooner has one coder found an interesting solution to a customer need, every other coder in the vicinity is able to see what has been done and is able to easily reproduce it. Helped in no small part by the fact that in most parts of the world it is very difficult to protect the IP that might be associated with a new piece of software.

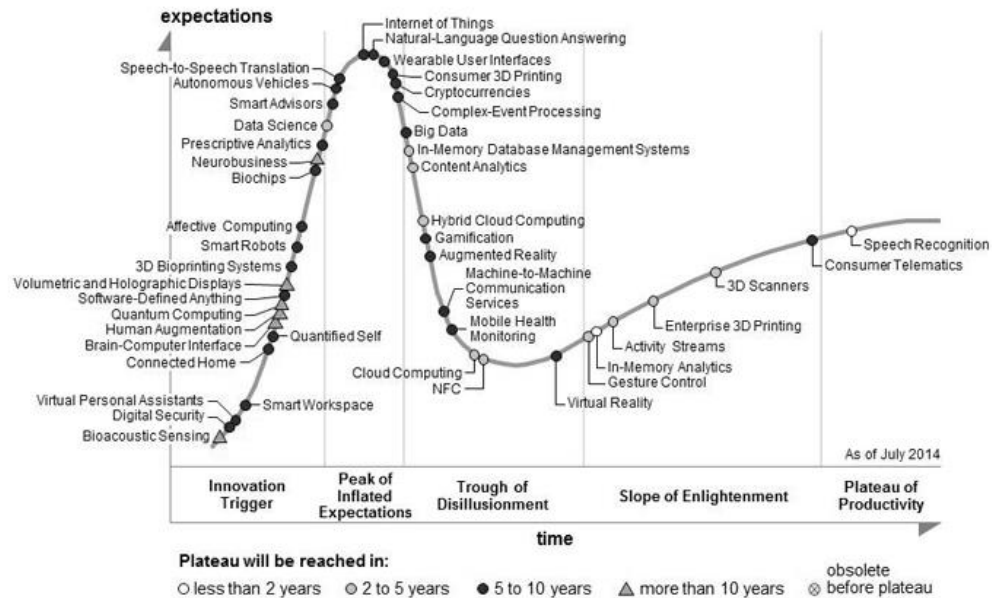

Fig. 8 Assorted IT Industry Innovation Attempts on the Hype Cycle

Taken together, these two factors perhaps indicate that the world of IT innovates ‘well enough’ already without the need for any kind of systematic process. We will return to that thought in the next section of the paper. Before that, however, we will make a small diversion to investigate what TRIZ and Systematic Innovation might have to tell us about the likely future direction and evolutionary potential of the software.

4.1 The ‘Ideal’ Software?

One of the pillars of TRIZ/SI is that all systems evolve in a direction of increasing ideality towards an ‘Ideal Final Result’ destination defined as the point when the system delivers all of the desired benefits (‘functions’) with zero negatives (typically defined as ‘costs’ and ‘harms’). Because fundamentally, as a system becomes more ideal, the number of effective solution possibilities becomes progressively smaller. This is counter-intuitive for most players and nearly

all industries. Refer to Figure 9, what it in effect means, if we plot an evolution story that connects current players with the evolutionary end point, it quickly becomes possible to identify the likely winners and losers. The Figure shown here for the IT industry as a generic whole makes no attempt to be comprehensive in terms of mapping a compendium of current players on the left-hand-side of the image, but it does contain the current biggest ones – the primary one being the IT Services industry and the millions of coders that work within it – and also the ones that will inevitably eventually supersede them. If the ‘ideal’ software, on the right-hand point of the cone, does everything it needs to do ‘by itself’ (is ‘autopoietic’ in the vernacular), then fundamentally it does not require programmers to create it anymore. Software Developers that aren’t associating themselves with the emerging worlds of affective computing, or Big Data Analytics or expert systems and genetic algorithms beware, evolutionary convergence clearly says your days are numbered.

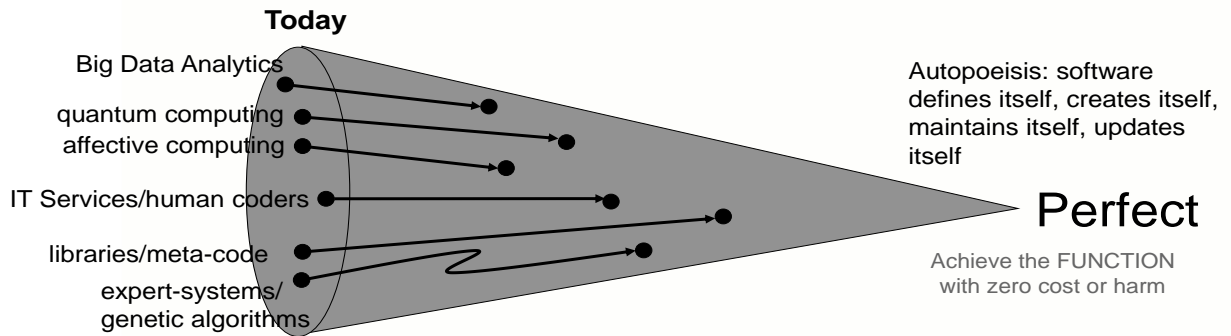

Fig. 9 Convergent Evolution of the IT industry towards its ‘Ideal Final Result’

So much for the evolutionary destination of ‘software’ and the software creation industry, we now shift the focus of attention to the Trends part of the TRIZ story in order to examine some of the key evolutionary jumps that the industry will likely make during the journey towards the autopoietic ‘ideal final result’ destination.

4.2 Evolution Potential

The original TRIZ research into the evolution of systems found within the physical world uncovered a number of patterns of evolution that have subse-

quently come to be described as the ‘Voice of the System’, or ‘signposts’ that direct innovators towards ideal solutions. The Systematic Software Innovation research program sought to identify whether there were equivalent signposts to be found in the IT industry. EvPot+ software analog contains 26 such evolution patterns. A parallel piece of research to do the same job in the world of business and management uncovered 32 (so far) patterns in that describe the evolution directions of an enterprise (Mann, 2009). Figure 10 illustrates a composite of Trend patterns from the IT and business worlds that are relevant to the IT industry.

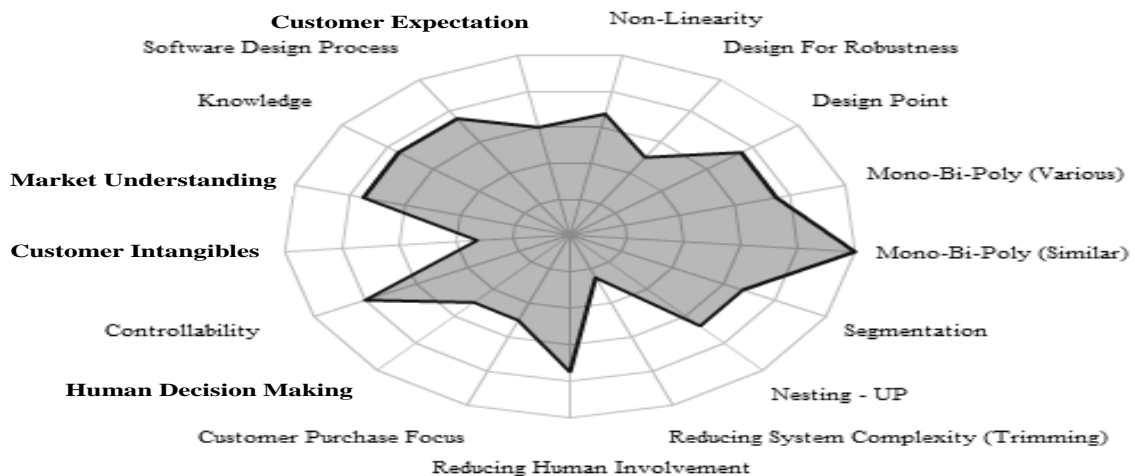

Fig. 10 Composite Evolution Potential Radar Plot of IT Industry

As is the usual convention with the resulting ‘Evolution Potential’ plot, each Trend is represented

by a spoke on the radar plot, and the plot details how far along a particular trend the industry has a whole

has thus far evolved. At this point in the evolutionary history, some 65% of the Evolution Potential has been utilized. Which in turn means that 35% of the possible evolution jumps the industry could make have thus far not been exploited. What might some of this untapped potential be able to tell innovators about the future likely solution directions of the industry as a whole? Again, this is a question that goes beyond the scope of the purpose of this paper, but by way of helping us to answer the earlier stated question about the future of innovation methods within the IT world, here are a few clues provided by the Trends:

1. *Controllability Trend* – software takes on predictive ('feed-forward') capabilities in order to anticipate its own future needs, and eventually becomes autopoietic.
2. *Reducing Human Involvement Trend* – human is progressively removed from the system at both the coding, but also specifier and customer ends of the value chain
3. *Customer Intangibles Trend* – software is increasingly capable of tapping into the emotional and 'unspoken' real needs of customers and users
4. *Nesting (Up) Trend* – software is increasingly integrated into higher level systems; source code becomes absorbed into higher level 'meta-languages' (*Mathematica, et al, where the user is able to design algorithms without ever having to learn how to code*)
5. *Design For Robustness Trend* – the software evolves to become more and more error-proof, to eventually become 'anti-fragile' – attempts to break the system end up making the system stronger
6. *Trimming Trend* – all of the superfluous software (the IT Services industry right now might be thought of as millions of smart people re-inventing the same basic wheels) will be 'trimmed' from systems such that what is left delivers all of the intended capability without unneeded excess.
7. *Customer Expectation Trend* – the software industry will shift from 'service' to 'experience' (taking care of the intangibles) to, eventually, 'transformation', at which point it will take over the responsibility for delivering the intended outcomes from the customer.
8. *Design Point Trend* – the software algorithms will learn how to adapt and reformulate themselves according to different operating regimes...
9. *Knowledge Trend* - ...until eventually it will be able to sense and adapt to the prevailing and emergent contexts of a given user situation.

And so with these clues firmly at the fore of our thinking, back to our final question...

5. Future Scope

Will TRIZ/SI ever find a role in the IT world? The answer to this question has to be yes. The answer is clear since Systematic Innovation fundamentally encapsulates a host of 'universal truths' – everything evolves towards an ideal end state, and will do so through a series of contradiction-solving, discontinuous (s-curve) jumps that follow a set of Evolutionary 'Laws'. In this sense, the IT world is no different from the physical world (Mann, 2011).

Beyond that high-level similarity, however, the virtual and physical worlds diverge considerably in the manner in which innovation happens. In the physical world, efficiency is important and every new solution iteration is expensive, requiring considerable human activity to make things happen. Consequently, it is important that enterprises looking to innovate in the physical world provide those expensive people resources with appropriate innovation efficiency raising skills. Training thousands of people in TRIZ/SI makes sound economic sense in this context.

In the virtual world, where ideas transfer very quickly, there is far less justification for training large numbers of people. 'All' that is required is that a small number of people are skilled in the universal

truths of TRIZ/SI to be able to encode them into systematic creativity algorithms.

There is a considerable irony in this story. TRIZ is and has always been about distilling the ‘DNA’ of innovation. Altshuller himself published a book called ‘The Innovation Algorithm’. Having created at least the start of such an algorithm, it becomes highly code-able. And the moment it does become coded and the IT world is presented with even the start of a meaningful ‘computer-aided innovation’ capability – especially one also equipped with (highly predictable) ‘self-updating’ capacity – then it removes the need for thousands of coders to do the creativity and innovation solution generation job manually. Paradoxically, by working out the ‘innovation algorithm’, TRIZ has ruled out the likelihood of widespread TRIZ deployment. At least from a visible-to-the-lay-person perspective. Most coders will never come to hear about TRIZ, but much of TRIZ will come pre-coded into the software kernels they get to work with. Only an elite few need ever know the ‘Innovation DNA’ to be able to upload it into

The authors believe that the future of TRIZ in the IT world is assured. Just not through training thousands of coders. But rather by being the first and best to encode the universal truths TRIZ research has revealed into a Systematic Software Innovation algorithm.

The big outstanding challenge in that world is how the inherent (monetary) value that comes through the TRIZ knowledge can be captured. In the physical world, it has been possible to capture at least a part of the monetary value of it through training large numbers of people, publishing books and selling TRIZ-based software tools. These models fundamentally can’t and won’t work in the virtual world. Millions of software engineers cannot be allowed to continue reinventing the same wheels because customers increasingly cannot afford them. There is, therefore, enormous business pressure to evolve software creation capability in the autopoietic direction. Perhaps we should contemplate inserting that challenge into the Systematic Software Innovation algorithm?

tomorrow’s software systems. The IT services sector is already hitting fundamental contradictions associated with increasing competition and reducing margins. In the West, the contradiction has been evident for a number of years already – as evidenced by the extraordinary amount of outsourcing of code development work to the developing parts of the world. But because the contradiction is present and causing pain, there is every incentive to resolve it by innovating the software development process such that, as outlined in the previous section. Software that ‘writes-itself’, ‘maintains itself, and ‘updates-itself’ solves massive business challenges for western organizations and so they have every incentive to derive and create such solutions. The recent release of TRIZ-based software systems like PanSensic being a case in point. Once a customer has installed a smart PanSensic dashboard, they are already halfway to automatically revealing future innovation opportunities and using the Trends and Inventive Principles to generate solutions. All without any need to teach any of their personnel anything at all about TRIZ.

6. Conclusion

Collaboration between different professionals is more and more necessary now (Khomeiko, 2010). Systematic innovation can help in this constructive collaboration. TRIZ is expected to play a major role in the design and development of software systems providing new capabilities that far exceed today’s levels of autonomy, functionality, usability and reliability. TRIZ absorption can be accelerated by close collaboration between academics and industry. This review paper provides detailed introduction to systematic innovation followed by brief introduction to TRIZ with a review of key tools inside the framework. An analysis of commercial and academic TRIZ software is presented next followed by a detailed literature review of systematic innovation in software engineering, finally views of subject matter experts in TRIZ area are presented to understand the current state of TRIZ application in software engineering and future scope. The authors hope that the review in this

paper will help academicians, researchers and software companies understand the current industry dynamics and help achieve investments in TRIZ for enhancing their existing and future software development process and products.

7. References

- Bradford, G. (2016). *TRIZ is now practiced in 50 countries*. Machine Design, March 21, 2016. <http://machinedesign.com/contributing-technical-experts/triz-now-practiced-50-countries>, accessed on April 21, 2016.
- Domb, E. (2003.) *TRIZ for Non-Technical Problem Solving*, The TRIZ journal Apr.
- Domb E and Stamey J. W. (2006). *Describing Design patterns in software engineering*.
- Fenn, J. and Rascino, M. (2008). *Mastering The Hype Cycle: How To Chose The Right Innovation At The Right Time*, Harvard Business School Press.
- Fulbright, R. (2004). *TRIZ and Software Fini*.
- Goyal, S. B. (2012). *Analyzing Object Model with Theory of Innovative solution*.
- Nakagawa T. (2005a). *SOFTWARE ENGINEERING AND TRIZ* (structured programming review with triz),
- Nakagawa T. (2005b). *SOFTWARE ENGINEERING AND TRIZ* (2) (step wise refinement and jackson method review),
- Ng, D. I. (2013). *Innovation in Service Delivery TRIZ in IT & Retails*.
- Odintsov, I. (2009). *TRIZ methods in SW development to enhance the productivity*
- Rea, K. C. (1999) *Using TRIZ in Computer Science - Concurrency*, the TRIZ journal
- Rea, K. C. (2000a). *TRIZ and Software - 40 Principle Analogies, Part 1*, the TRIZ journal.
- Rea, K. C. (2000b). *TRIZ and Software - 40 Principle Analogies, Part 2*, the TRIZ journal.
- Rea, K. C. (2002). *Applying TRIZ to Software Problems -Creatively Bridging Academia and Practice in Computing*, TRIZCON2002.
- Rea, K. C. (2005). *TRIZ for Software Using the Inventive Principles*.
- Sheu, D. D. (2015). *Mastering TRIZ Innovation Tools: Part I*, Agitek International Consulting, Inc, 4th Ed.
- Sheu, D. D. and Lee, H.K. (2010). *A Proposed Classification and Process of Systematic Innovation*, International Journal of Systematic Innovation,1(1) , 3-22.
- Hartmann H, Vermeulen and Beers M. V. (2004) *Application of TRIZ in Software Development*.
- Hyun, J. S. (2009). *A Conflict-Based Model for Problem-Oriented Software Engineering and Its Applications Solved by Dimension Change and Use of Intermediary*.
- Ilevbare, M. I, Probert D and Phaal R (2013) *A review of TRIZ*, and its benefits and challenges in practice.
- Khomenko, N(2010). *Keynote presentation for 6th TRIZ symposium* in Japan, Tokyo. September 2010
- Kluender, D. (2011). *TRIZ for software architecture in ScienceDirect*.
- Mann, D. L. (2008) *Systematic(Software) Innovation* IFR Press
- Mann, D. L. (2006). *Updating TRIZ: 2006-2008 Patent Research Findings*, keynote address, 4th Japanese TRIZ Symposium.
- Mann, D. L. (2007). *Hands-On Systematic Innovation For Business & Management*, IFR Press.
- Mann, D. L. (2011). *TRIZ and Software Innovation: Historical Perspective And An Application Case*.
- Mann, D. L. (2012) *Innovation Capability Maturity Model: An Introduction*, IFR Press,.
- Song, K. K. (2009). *Design of Enhanced software protection architecture by using theory of inventive problem solving*.
- Souchkov, V. (2007-2014). *Breakthrough Thinking With TRIZ For Business And Management: An Overview*, ICG Training & Consulting, retrieved from www.xtriz.com.
- Stamey, J. W. (2006.). *TRIZ and Extreme Programming*.
- Subramanian, R. (2007) *Applying TRIZ in Information Technology outsourcing*.
- Tillaart. R.V.D. (2006) *TRIZ and Software - 40 Principle Analogies, a sequel*.
- Toivonen, T. (2014). *The continuous innovation model - combining Toyota Kata and TRIZ*.
- Wang, S. H. (2011). *Software Development and quality problems and solutions by TRIZ in ScienceDirect*.
- Zadesenets, I. (2009). *Using TRIZ to Resolve Software Interface Problems*.
- Zlotin B and Zusman A. (2005). *Theoretical and practical aspects of development of TRIZ- based software systems*.

AUTHOR BIOGRAPHIES



Dongliang Daniel Sheu is a Professor at National Tsing Hua University in Taiwan since 1996. Before then, he has 9 years of industrial experience in the electronic industries with Hewlett-Packard, Motorola, and Matsushita. Daniel received his Ph.D. degree in engineering from UCLA and MBA degree from Kellogg Graduate School of Management at Northwestern University. He also holds a B.S.M.E. degree from National Taiwan University and an M.S.M.E. degree from State University of New York at Buffalo. He is currently the President of the International Society of Innovation Methods, Honorary President of the Society of Systematic Innovation, Editor-in-chief of the International Journal of Systematic Innovation, and Area Editor of the Computers and Industrial Engineering Journal. His areas of interest include Systematic Innovation (TRIZ++), Innovation Management, Patent Technical Analysis, Equipment Management, and Factory Diagnosis.



Usharani Hareesh Govindarajan currently teaches in the role of an Adjunct Assistant Professor in National Tsing Hua University, Taiwan. Dr. Hareesh received his Doctorate from the National Tsing Hua University from the Department of Industrial Engineering and Engineering Management, prior to which he received a Master's in Engineering in Computer Science from AUUP (India), and a Master in Science from the Delhi University (India). His research interests include full stack software systems integration research, analytics on patent data for management information support.



Darrell Mann spent 15 years working at Rolls-Royce and ultimately became Chief Engineer of the company. He left the company in 1996 to help set up a high-technology company spin-out from Imperial College, London, before entering systematic innovation research at the University of Bath. He started using Systematic Innovation in 1992 and teaching Systematic Innovation methods in 1998. Darrell has given workshops to over 15,000 delegates. With over 800 systematic innovation-related papers and articles, plus the best-selling 'Hands-On Systematic Innovation' books, Darrell is now one of the most widely published authors on the innovation subject in the world. He is CEO of Systematic Innovation Ltd, a UK-based innovation company with offices and affiliates in India, Malaysia, China, Denmark, Turkey, Australia, US and Austria. Darrell is now recognised as one of the world's most prolific inventors. He is a Professor at the University of Buckingham in the UK, and Taylor's University in Malaysia.

INSTRUCTIONS TO AUTHORS

Submission of Papers

The International Journal of Systematic Innovation is a refereed journal publishing original papers four times a year in all areas of SI. Papers for publication should be submitted online to the IJoSI website (<http://www.ijosi.org>) In order to preserve the anonymity of authorship, authors shall prepare two files (in MS Word format or PDF) for each submission. The first file is the electronic copy of the paper without author's (authors') name(s) and affiliation(s). The second file contains the author's (authors') name(s), affiliation(s), and email address(es) on a single page. Since the Journal is blind refereed, authors should not include any reference to themselves, their affiliations or their sponsorships in the body of the paper or on figures and computer outputs. Credits and acknowledgement can be given in the final accepted version of the paper.

Editorial Policy

Submission of a paper implies that it has neither been published previously nor submitted for publication elsewhere. After the paper has been accepted, the corresponding author will be responsible for page formatting, page proof and signing off for printing on behalf of other co-authors. The corresponding author will receive one hardcopy issue in which the paper is published free of charge.

Manuscript Preparation

The following points should be observed when preparing a manuscript besides being consistent in style, spelling, and the use of abbreviations. Authors are encouraged to download manuscript template from the IJoSI website, <http://www.ijosi.org>.

1. *Language.* Paper should be written in English except in some special issues where Chinese maybe acceptable. Each paper should contain an abstract not exceeding 200 words. In addition, three to five keywords should be provided.
2. *Manuscripts.* Paper should be typed, single-column, double-spaced, on standard white paper margins: top = 25mm, bottom = 30mm, side = 20mm. (The format of the final paper prints will have the similar format except that double-column and single space will be used.)
3. *Title and Author.* The title should be concise, informative, and it should appear on top of the first page of the paper in capital letters. Author information should not appear on the title page; it should be provided on a separate information sheet that contains the title, the author's (authors') name(s), affiliation(s), e-mail address(es).
4. *Headings.* Section headings as well as headings for subsections should start front the left-hand margin.
5. *Mathematical Expressions.* All mathematical expressions should be typed using Equation Editor of MS Word. Numbers in parenthesis shall be provided for equations or other mathematical expressions that are referred to in the paper and be aligned to the right margin of the page.
6. *Tables and Figures.* Once a paper is accepted, the corresponding author should promptly supply original copies of all drawings and/or tables. They must be clear for printing. All should come with proper numbering, titles, and descriptive captions. Figure (or table) numbering and its subsequent caption must be below the figure (or table) itself and as typed as the text.
7. *References.* Display only those references cited in the text. References should be listed and sequenced alphabetically by the surname of the first author at the end of the paper. References cited in the text should appear as the corresponding numbers in square bracket with or without the authors' names in front. For example
Altshuller, G.,1998. *40 Principles: TRIZ Keys to Technical Innovation*, Technical Innovation Center.
Sheu, D. D., 2007. Body of Knowledge for Classical TRIZ, *the TRIZ Journal*, 1(4), 27-34.

**The International Journal of Systematic Innovation
Journal Order Form**

| | |
|--|--|
| Organization Or Individual Name | |
| Postal address for delivery | |
| Person to contact | Name: _____ e-mail: _____ Position: _____ School/Company: _____ |
| Order Information | <p>I would like to order ___ copy (ies) of the <i>International Journal of Systematic Innovation</i>:</p> <p>Period Start: 1st/ 2nd half _____, Year: _____ (Starting 2010)</p> <p>Period End : 1st/ 2nd half _____, Year: _____</p> <p>Price:</p> <p>Institutions: US \$90 (yearly) / NT 2,800 (In Taiwan only)</p> <p>Individuals: US \$30 (yearly) / NT 950 (In Taiwan only)</p> <p>(Surface mail postage included. Air mail postage extra)</p> <p>E-mail to: IJoSI@systematic-innovation.org or fax: +886-3-572-3210</p> <p>Air mail desired <input type="checkbox"/> (If checked, we will quote the additional cost for your consent)</p> |
| Total amount due | US\$ |
| Payment Methods: 1. Credit Card (Fill up the following information and e-mail/ facsimile this form to The Journal office indicated below) 2. Bank transfer Account: The Society of Systematic Innovation Bank Name: Mega International Commercial BANK Account No: 020-53-144-930 SWIFT Code: ICBCTWTP020 Bank code : 017-0206 Bank Address: No. 1, Xin'an Rd., East Dist., Hsinchu City 300, Taiwan (R.O.C.) | |

**VISA / Master/ JCB/ AMERICAN Cardholder Authorization for Journal Order
Card Holder Information**

| | | | |
|---|-------------------------|------------------|--|
| Card Holder Name | (as it appears on card) | | |
| Full Name (Last, First Middle) | | | |
| Expiration Date | / (month / year) | Card Type | <input type="checkbox"/> VISA <input type="checkbox"/> MASTER <input type="checkbox"/> JCB |
| Card Number | □□□□-□□□□-□□□□-□□□□ | Security Code | □□□  |
| Amount Authorized | | Special Messages | |
| Full Address (Incl. Street, City, State, Country and Postal code) | | | |

Please Sign your name here _____ (same as the signature on your card)

The Society of Systematic Innovation
5 F, # 350, Sec. 2, Guanfu Rd, Hsinchu,
Taiwan, 30071, R.O.C.

Copyright Page

Title: International Journal of System Innovation

Editor : Sheu, Dongliang Daniel

Chief Editor : Sheu, Dongliang Daniel

Issuer : The Society of Systematic Innovation

Publishing Company : The Society of Systematic Innovation

Address : 5F., No.350, Sec. 2, Guangfu Rd., Hsinchu 30071, Taiwan (R.O.C.)

TEL : +886-3-572-3200

FAX : +886-3-572-3210

EMAIL : editor@ssi.org.tw; service@ssi.org.tw

ISSN (Print) : 2077-7973

ISSN (Online): 2077-8767

Issues : VOL.05, NO.03 (March, 2019)

All rights reserved. No part of this book may be reproduced, in any form or by any means, without permission in writing from the publisher